

THIS IS A CONSOLIDATED DISCLOSURE STATEMENT FILED PURSUANT TO THE REAL ESTATE DEVELOPMENT MARKETING ACT

**DISCLOSURE STATEMENT
OF
NORTHLAND PROPERTIES CORPORATION**

(Original Disclosure Statement dated April 4, 2025 and Amendments to Disclosure Statement dated May 22, 2025, May 28, 2025, February 23, 2026, and April 2, 2026)

Developer: **Northland Properties Corporation**

Address for service in **310 – 1755 West Broadway**
In British Columbia: **Vancouver, British Columbia, V6J 4S5**

Mailing Address: **310 – 1755 West Broadway**
Vancouver, British Columbia, V6J 4S5

Real Estate Brokerage: **Revelstoke Mountain Realty Inc.**
122 Mackenzie Avenue
Revelstoke, BC V0E 2S0

THIS DISCLOSURE STATEMENT MAY HAVE BEEN DELIVERED TO THE PURCHASER(S) BY ELECTRONIC MEANS. _____ <i>[INSERT PURCHASER(S) NAME]</i> , SPECIFICALLY CONSENT, PURSUANT TO SECTION 15(3) OF THE REAL ESTATE DEVELOPMENT MARKETING ACT, TO ACCEPT RECEIPT OF THIS DISCLOSURE STATEMENT BY ELECTRONIC MEANS.		
	INITIAL	INITIAL

THIS DISCLOSURE STATEMENT RELATES TO A DEVELOPMENT PROPERTY THAT IS NOT YET COMPLETED. PLEASE REFER TO SECTION 7.2 FOR INFORMATION ON THE PURCHASE AGREEMENT. THAT INFORMATION HAS BEEN DRAWN TO THE ATTENTION OF _____ <i>[INSERT PURCHASER(S) NAME]</i> , WHO HAS CONFIRMED THAT FACT BY INITIALING IN THE SPACE PROVIDED HERE.		
	INITIAL	INITIAL

THIS DISCLOSURE STATEMENT HAS BEEN FILED WITH THE SUPERINTENDENT OF REAL ESTATE, BUT NEITHER THE SUPERINTENDENT, NOR ANY OTHER AUTHORITY OF THE GOVERNMENT OF THE PROVINCE OF BRITISH COLUMBIA, HAS DETERMINED THE MERITS OF ANY STATEMENT CONTAINED IN THE DISCLOSURE STATEMENT, OR WHETHER THE DISCLOSURE STATEMENT CONTAINS A MISREPRESENTATION OR OTHERWISE FAILS TO COMPLY WITH THE REQUIREMENTS OF THE REAL ESTATE DEVELOPMENT MARKETING ACT. IT IS THE RESPONSIBILITY OF THE DEVELOPER TO DISCLOSE PLAINLY ALL MATERIAL FACTS, WITHOUT MISREPRESENTATION.

RIGHT OF RESCISSION

Under section 21 of the *Real Estate Development Marketing Act*, the purchaser or lessee of a development unit may rescind (cancel) the contract of purchase and sale or contract to lease by serving written notice on the developer or the developer's brokerage, within seven (7) days after the later of the date the contract was entered into or the date the purchaser or lessee received a copy of this disclosure statement.

A purchaser may serve a notice of rescission by delivering a signed copy of the notice in person or by registered mail to:

- (A) the developer at the address shown in the disclosure statement received by the purchaser,
- (B) the developer at the address shown in the purchaser's purchase agreement,
- (C) the developer's brokerage, if any, at the address shown in the disclosure statement received by the purchaser, or
- (D) the developer's brokerage, if any, at the address in the purchaser's purchase agreement.

The developer must promptly place purchasers' deposits with a brokerage, lawyer or notary public who must place the deposits in a trust account in a savings institution in British Columbia. If a purchaser rescinds their purchase agreement in accordance with the Act and regulations, the developer or the developer's trustee must promptly return the deposit to the purchaser.

TABLE OF CONTENTS

1. **THE DEVELOPER**
 - 1.1 Developer
 - 1.2 Purpose of Developer
 - 1.3 Particulars of Developer
 - 1.4 Directors/Officers of Developer
 - 1.5 Background of Developer
 - 1.6 Conflicts of Interest of Developer

2. **GENERAL DESCRIPTION**
 - 2.1 General Description of the Development
 - 2.2 Permitted Use
 - 2.3 Phasing

3. **STRATA INFORMATION**
 - 3.1 Unit Entitlement
 - 3.2 Voting Rights
 - 3.3 Common Property and Facilities
 - 3.4 Limited Common Property
 - 3.5 Bylaws
 - 3.6 Parking
 - 3.7 Furnishings and Equipment
 - 3.8 Budget
 - 3.9 Utilities and Services
 - 3.10 Strata Management Contracts
 - 3.11 Insurance

4. **TITLE AND LEGAL MATTERS**
 - 4.1 Legal Description
 - 4.2 Legal Ownership
 - 4.2A Beneficial Ownership
 - 4.3 Existing Encumbrances and Legal Notations
 - 4.4 Proposed Encumbrances
 - 4.5 Outstanding or Contingent Litigation or Liabilities
 - 4.6 Environmental Matters

5. CONSTRUCTION AND WARRANTIES

- 5.1 Construction Dates
- 5.2 Warranties
- 5.3 Previously Occupied Building

6. APPROVALS AND FINANCES

- 6.1 Development Approval
- 6.2 Construction Financing

7. MISCELLANEOUS

- 7.1 Deposits
- 7.2 Purchase Agreement
- 7.3 Developer's Commitments
- 7.4 Other Material Facts

8. SIGNATURES

- Deemed Reliance
- Declaration
- List of Schedules
 - Schedule "A" Draft Strata Plan
 - Schedule "B" CD-02 Zone
 - Schedule "C" Form P, Phased Strata Plan Declaration
 - Schedule "D" Proposed Schedule of Unit Entitlement
 - Schedule "E" Proposed Bylaws
 - Schedule "F" Estimated Interim Budget
 - Schedule "G" Rent Charge/219 Covenant
 - Schedule "H" Rental Restriction Covenant
 - Schedule "I" Common Lot Covenant
 - Schedule "J" Contract of Purchase and Sale

1. THE DEVELOPER

1.1 Corporate Developer

Northland Properties Corporation was continued into the Province of British Columbia pursuant to the *Business Corporations Act* (British Columbia) on November 24, 2008 under incorporation number C0839976 (the “Developer”).

1.2 Purpose of Developer

The Developer was not created for the sole purpose of developing the Strata Lots detailed in this Disclosure Statement and holds other assets.

1.3 Particulars of Developer

The registered and records offices for the Developer is 310 – 1755 Broadway West, Vancouver, British Columbia, V6J 4S5.

1.4 Directors of Developer

The sole director of the Developer is:

Name: Robert Thomas Gaglardi
Address: #310 – 1755 West Broadway
Vancouver, BC V6J 4S5

1.5 Background of the Developer

- (a) The Developer has significant experience in the development, hospitality, and tourism industries. Its sole director, Robert Thomas Gaglardi, has 40 years of hands-on experience in hospitality, real estate, and construction industries.
- (b) To the best of the Developer’s knowledge, none of the Developer, or any principal holder of the Developer (being a person who holds, directly or indirectly, more than 10% of any class of voting securities of the Developer), or any director or officer of the Developer or principal holders, within the ten years before the date of the Developer’s declaration attached to this Disclosure Statement, has been subject to any penalties or sanctions imposed by a court or regulatory authority relating to the sale, lease, promotion, or management of real estate or securities, or to lending money secured by a mortgage of land, or to arranging, administering or dealing in mortgages of land, or to theft or fraud.
- (c) To the best of the Developer’s knowledge, none of the Developer, or any principal holder of the Developer, or any director or officer of the Developer or principal holders, within the five years before the date of the Developer’s declaration attached to this Disclosure Statement, was declared bankrupt or made a voluntary assignment in bankruptcy, made a proposal under any legislation relating to bankruptcy or insolvency or has been subject to or instituted any proceedings, arrangement or compromise with creditors or had a receiver, receiver manager or trustee appointed to hold the assets of that person.
- (d) To the best of the Developer’s knowledge, no director, officer, or principal holder of the Developer, or any director or officer of a principal holder, within the five years prior to the date of the Developer's declaration attached to the Disclosure Statement, has been

a director, officer, or principal shareholder of any other developer that, while that person was acting in that capacity, that other developer:

- (i) was subject to any penalties or sanctions imposed by a court or regulatory authority relating to the sale, lease, promotion, or management of real estate or securities, or to lending money secured by a mortgage of land, or to arranging, administering, or dealing in mortgages of land, or to theft or fraud;
- (ii) was declared bankrupt or made a voluntary assignment in bankruptcy, made a proposal under any legislation relating to bankruptcy or insolvency or has been subject to or instituted any proceedings, arrangement or compromise with creditors or had a receiver, receiver manager or trustee appointed to hold its assets.

1.6 Conflicts of Interest of the Developer

There are no existing or potential conflicts of interest of the Developer, its directors, officers, and principal holders with respect to the Development which would reasonably be expected to affect the purchaser's purchase decision, except the following:

- (a) the Developer, or an affiliate of the Developer, may become the strata manager for the Development;
- (b) an affiliate of the Developer will be entitled to the benefit of a rental restriction covenant that would restrict the rental of the Strata Lots (See section 4.4 of this Disclosure Statement); and
- (c) an affiliate of the Developer will be entitled to the benefit of a rent charge to secure contribution to common amenities and services available for use by the owners of the Strata Lots including, but not limited snow removal, landscaping, resort banners and signage, skating rink or tennis courts (See section 4.4 of this Disclosure Statement).

2. **GENERAL DESCRIPTION OF THE DEVELOPMENT**

2.1 General Description of the Development

- (a) This is a strata development (the "Development") located off Nichol Road, in Revelstoke, British Columbia, which will include 16 strata lots that will be owned individually, together with a proportionate share in the common property including common facilities ("Common Property") and other assets of the Strata Corporation which will be owned as tenants in common by the owners of the Strata Lots.

The development will consist of four 3-storey wood-frame row townhouse-style buildings, with each building containing 4 strata lots (the "Strata Lots").

(b)	<u>Type of Building</u>	<u>Number of Buildings</u>
	Row Townhouse	4
(c)	<u>Type of Construction</u>	<u>Number of Buildings</u>
	Wood-frame	4

(d)	<u>Total Strata Lots</u>	16
(e)	<u>Type of Strata Lots</u>	<u>Number of Strata Lots</u>
	3 bedroom with optional bedroom and studio suite	8
	2 bedroom with optional studio suite	8

The draft strata plan for the Development is attached as Schedule “A”.

The Strata Lots will be created upon the deposit of a Strata Plan (the “Strata Plan”) in respect thereof in the Nelson Land Title Office.

Prior to entering into a contract of purchase and sale for a Strata Lot, the Developer reserves the right to change the layout of the Strata Lots. The Unit Entitlement of the Strata Lots will not change.

2.2 Permitted Use

The present zoning of the Development is CD-02, a copy of which is attached as Schedule “B” to this Disclosure Statement. The Property, as hereinafter defined, is contained within Resort Area 4 (Resort Neighbourhood) of the CD-02 Zone which permits, among other uses, multi-family dwellings. Commercial uses are permitted within the CD-02 Zone, but commercial activities may be restricted by the building construction restrictions set out in section 4.4. of this Disclosure Statement. More information and details about zoning requirements and permissible uses is available from the City of Revelstoke Development Services Department by phone at 250-837-3637 or by email at development@revelstoke.ca.

2.3 Phasing

The Development will be constructed in 4 phases, as follows:

- Phase 1 1 Row Townhouse-style building consisting of 4 Strata Lots each
- Phase 2 1 Row Townhouse-style building consisting of 4 Strata Lots each
- Phase 3 1 Row Townhouse-style building consisting of 4 Strata Lots each
- Phase 4 1 Row Townhouse-style building consisting of 4 Strata Lots each

The Developer is currently marketing all phases of the Development, and this Disclosure Statement relates to the entire Development.

The Developer is not required to proceed with future phases and may elect to not proceed with the other phases of the Development.

A Phased Strata Plan Declaration must be approved by the approving officer and filed with the Strata Plan. The Phased Strata Plan Declaration describes important information of the phased development including the location and area of each phase and the location of the common facilities.

The Phased Strata Plan Declaration has not yet been approved by the approving officer for the City of Revelstoke. A copy of the proposed Form P, Phased Strata Plan Declaration is attached as Schedule "C" to this Disclosure Statement.

3. **STRATA INFORMATION**

3.1 Unit Entitlement

The unit entitlement of each Strata Lot is a figure indicating the share of an owner in the common property, common facilities, and other assets of the strata corporation (the "Strata Corporation"). It is also the figure used to determine the owner's contribution toward the common expenses. The Developer has set the unit entitlement for each Strata Lot as 1.

Attached as Schedule "D" is the proposed Schedule of Unit Entitlement.

3.2 Voting Rights

Each Strata Lot shall have one (1) vote in the Strata Corporation.

3.3 Common Property and Facilities

These will be no common facilities within the Development. Common property and amenities included in the Development are as follows:

landscaped areas/grounds and paths/walkways, if any.

3.4 Limited Common Property

Limited Common Property is an area within the Common Property that may be used exclusively by one or more Strata Lot owners. The Developer will establish on the Strata Plan decks and driveways as limited common property for the exclusive use of designated Strata Lots.

Bylaws two (2) and eight (8) of the Bylaws require an owner to maintain and repair limited common property designated for its use, save for the limited common property which the Strata Corporation is required to repair and maintain as follows:

- (i) repair and maintenance that in the ordinary course of events occurs less than once a year;
- (ii) the structure of the buildings;
- (iii) the exterior of the buildings;
- (iv) chimney, stairs, balconies, and other things attached to the exterior of the buildings;
- (v) doors, and windows, on the exterior of the buildings or that front the common property;
- (vi) fences, railings, and similar structures that enclose patios, balconies, and yards.

3.5 Bylaws

The Bylaws of the Strata Corporation shall be the Bylaws as set out in Schedule "E" to this Disclosure Statement. The Bylaws contain the following restrictions:

- (a) a restriction on the number and types of pets at section 3.13; and
- (b) a restriction on smoking at section 35.

3.6 Parking

Each strata lot will have a single car enclosed garage included as part of the Strata Lot. The driveway to each Strata Lot will be designated as limited common property for exclusive use by the designated Strata Lot. The Development will not include any visitor parking stalls. Visitor parking will be available on the common lot road by which access to the Development is obtained (See Sections 3.9(f) and 4.4 of this Disclosure Statement).

3.7 Furnishings and Equipment

The furnishings and equipment included with each Residential Strata Lot are:

washer/dryer, refrigerator, electric range, microwave, dishwasher and window coverings

3.8 Budget

Attached and marked as Schedule "F" is a copy of the estimated interim budget of the Strata Corporation showing how the budget will be allocated amongst the individual Strata Lot owners. The budget includes the estimated costs of the Strata Corporation in respect of its interest in the common lot road and the obligation to contribute the repair and maintenance of same (See Sections 3.9(f) and 4.4 of this Disclosure Statement).

3.9 Utilities and Services

(a) Water

The Development will be serviced by a water system provided by the City of Revelstoke and water lines will be installed to each Strata Lot.

(b) Electricity

The Development will be serviced with electricity by British Columbia Hydro and Power Authority and electrical service will be available to each Strata Lot.

(c) Sewerage

The Development will be serviced by municipal sewer by agreement with the City of Revelstoke.

(d) Fire Protection

Fire protection for the Development is provided by the City of Revelstoke Fire Rescue Services. Fire protection facilities are located approximately three kilometers from the Development. Fire hydrants will be located as per building guidelines on the common lot road.

(e) Telephone

Telephone service for the Development is provided by Telus, and telephone service will be available to each Strata Lot.

(f) Access

Access to the Development will be provided by way of a common lot road, in which the Development Property will have a 1/78 undivided interest, together with all such other lots or strata lots that may be created by way of deposit of a subdivision plan or strata plan of the lands from which the Development Property is created. A covenant setting out the cost-sharing arrangement requirements with respect to the maintenance and repair of the common lot, including, but not limited to utility and other infrastructure and landscaping, will be registered against title to the Development Property (See Section 4.4 of this Disclosure Statement).

(g) Propane Service

The Developer will arrange for a third party utility company to provide propane service to the Development, and propane service will be available to each Strata Lot.

(h) Geothermal

The Developer will construct a geothermal loop system located under the driveways designated as limited common property which will be owned and operated by a third party and geothermal heating and cooling will be available to each Strata Lot.

3.10 Strata Management Contracts

The Developer will cause the Strata Corporation to enter into a strata management contract with a manager that is yet to be determined. The Developer, or an entity controlled by the Developer, may become the Strata Manager of the Development.

3.11 Insurance

The Developer has the following insurance coverage in place for the Development:

(a) Developer Coverage

The Developer will be placing builders risk insurance coverage in respect of the Development covering losses on buildings.

(b) Strata Coverage

The Developer will replace the insurance coverage set out above on registration of the strata plan with the following coverage:

Full replacement cost insurance on common property, common assets, buildings shown on the Strata Plan, and fixtures, built or installed on the Strata Lots by the Developer as part of the original construction. Such full replacement cost insurance will insure against major perils, including fire, lightning, smoke, windstorm, hail, explosion, water escaping, strikes, riots or civil commotion, impact by aircraft and vehicle, vandalism, and malicious acts. The Strata Corporation will also have liability insurance against liability for property damage and bodily damage in an amount not less than \$5,000,000.00.

(c) Owner Coverage

The Purchaser is responsible for insuring the Strata Lot, including the contents of the Purchaser's Strata Lot. Section 3.8 of the Bylaws requires each owner to obtain liability insurance for an amount not less than \$2,000,000.00 and provide proof of such insurance as required.

4. **TITLE AND LEGAL MATTERS**

4.1 Legal Description

The legal description of the property on which the Development will be situate is:

PID: 010-884-165 The southeast quarter of Section 23, Township 23, Range 2 West of the 6th Meridian, Kootenay District except (1) Parcel A (Reference Plan 6926) and (2) parts included in Plans 8496, 14766, NEP19168, NEP19836 and NEP83496 (the "Southeast Quarter Property")

PID: 014-013-924 The north half of the southwest quarter of Section 23, Township 23, Range 2 West of the 6th Meridian, Kootenay District except (1) part included in Plan 11424, (2) Parcel 1 (reference plan 7168) and (3) Parcel A (reference Plan 48414) (the "North Half Property")

(collectively the "Property").

4.2 Ownership

The Southeast Quarter Property is legally owned by Northland Properties Corporation and the North Half Property is legally owned by Revelstoke Alpine Village Inc.

4.2A Consolidated Lands

The Developer has the right to acquire a portion of the North Half Property and will consolidate that portion with the Southeast Quarter Property to create the parent parcel (the "Parent Parcel") which will be further subdivided to create the lands upon which the Development will be constructed (the "Development Property). Upon registration of the plan to subdivide the Parent Parcel, the Development Property will be legally described as Lot 2, Section 23, Township 23,

Range 2 West of the 6th Meridian, Kootenay District, Plan EPP _____, and an undivided 1/78 interest in Lot 1, Section 23, Township 23, Range 2 West of the 6th Meridian, Kootenay District, Plan EPP _____.

4.3 Existing Legal Notations and Encumbrances

Legal Notations

- (a) Permits under Part 14 or Part 26 of the Local Government Act (See CB1415541, CB1415601, CB1960540, LB64633, CA9554509, CB1642335, CB1724455 and CB1964085 (Pending));

Encumbrances

- (b) Restrictive Covenant R15891 in favour of His Majesty the King in right of the Province of British Columbia, as represented by the Ministry of Transportation and Transit restricting development within 15 meters of the natural boundary of any watercourse or within 7.5 meters of the natural boundary of any lake or marsh;
- (c) Statutory Right of Way CB1555467 in favour of BC Hydro and Power Authority for the installation, maintenance, repair and replacement of electrical works;
- (d) Statutory Right of Way CB1555468 in favour of Telus Communications Inc. for the installation, maintenance, repair and replacement of telecommunication works;
- (e) Covenant KN94878 in favour of the City of Revelstoke relating to restricted development uses except in accordance with the terms of the covenant;
- (f) Mortgage LB115076 (as extended by LB239401, LB315870 and CA5625721 and modified by LB318706) in favour of the Developer;
- (g) Assignment of Rents LB115077 (as extended by LB239402, LB315871 and CA5625722) in favour of the Developer;
- (h) Covenant CA8687746 in favour of the City of Revelstoke requiring compliance with an environmental monitoring plan in compliance with the federal *Migratory Birds Act* and the provincial *Wildlife Act*;
- (i) Statutory Right of Way CB1561964 in favour of FortisBC Energy Inc., for the installation, maintenance and repair of gas distribution systems;
- (j) Statutory Right of Way CB1841030 in favour of British Columbia Hydro and Power Authority for the installation, maintenance and repair of electrical distribution works; and
- (k) Statutory Right of Way CB184031 in favour of Telus Communications Inc for the installation, maintenance and repair of telecommunication systems.

The foregoing Legal Notations and Encumbrances may not charge both titles that presently comprise the Property and may or may not carry to title for the Development Property upon registration of the consolidation and subdivision plans to create the Development Property. The Mortgage and Assignment of Rents in favour of Northland Properties Corporation will be discharged prior to the conveyance of a Strata Lot to a purchaser, or in accordance with undertakings between the Developer's lawyer and purchaser's lawyer.

Copies of these charges may be obtained from the Developers' solicitors, Pushor Mitchell, LLP, 301 – 1665 Ellis Street, Kelowna, BC V1Y 2B3. Phone: 250-762-2108.

4.4 Proposed Encumbrances

Easements or statutory rights of way in favour of the appropriate utilities or authority for storm and sanitary sewers, water, hydro electricity, gas lines and geothermal equipment may be required over various strata lots to service the Development. The locations of these easements and statutory rights of way will not materially affect the Development.

Covenants or other agreements in favour of the City of Revelstoke as may be necessary or required to permit construction of the Development.

Rent Charge in favour of an affiliate of the Developer to secure contribution to common amenities and services available for use by the owners of the Strata Lots including, but not limited snow removal, landscaping not part of privately owned lands, resort banners and signage, skating rink or tennis courts, located within the Revelstoke Mountain Resort community, substantially in the form attached as Schedule "G" to this Disclosure Statement.

Restrictive Covenant in favour of an affiliate of the Developer mandating that the rental of any Strata Lots within the Development may only be rented in accordance with the covenant, substantially in the form attached as Schedule "H" to this Disclosure Statement.

Covenant in favour of an affiliate of the Developer restricting use of the common lot for the purposes of access and utilities only and requiring compliance with the cost-sharing arrangements with respect to the maintenance and repair of the common lot, including, but not limited to utility and other infrastructure and landscaping, substantially in the form attached as Schedule "I" to this Disclosure Statement.

Permits under the Local Government Act may be added as Legal Notations to the title of the Property by the City of Revelstoke relating to development requirements for the Development Property, including form and character of the buildings and other matters.

4.5 Outstanding or Contingent Litigation or Liabilities

There are no outstanding or contingent litigation or liabilities in respect of the Development or against the Developer that may affect the Strata Corporation or the Strata Lot owners other than those financial liabilities set out in sections 4.3 or 4.4 of this Disclosure Statement.

4.6 Environmental Matters

There are no concerns related to flooding, the condition of soil and subsoil or other environmental matters affecting Property.

5. **CONSTRUCTION AND WARRANTIES**

5.1 Construction Dates

The estimated Commencement of Construction and Completion of Construction dates are as follows:

<u>Phase</u>	<u>Estimated Commencement of Construction Date</u>	<u>Estimated Completion of Construction Date</u>
1	April 1, 2025 – June 30, 2025	September 1, 2026 – November 30, 2026
2	June 1, 2025 – August 30, 2025	November 1, 2026 – January 30, 2027
3	August 1, 2025 – October 30, 2025	January 1, 2027 – March 30, 2027
4	December 1, 2025 – February 28, 2026	March 1, 2027 – May 30, 2027

Construction may complete prior to the Completion of Construction Date specified.

For the purposes of this section:

“Commencement of Construction” means the date of commencement of excavation in respect of construction of an improvement that will become part of a development unit within the development property, and where there is no excavation, it means the date of commencement of construction of an improvement that will become part of a development unit within the development property; and

“Completion of Construction” means the first date that a development unit within the development property may be lawfully occupied, even if such occupancy has been authorized on a provisional or conditional basis.

5.2 Warranties

The Developer will provide home warranty insurance through Travelers Insurance Company of Canada, which will provide a limited warranty to the owners of the Strata Lots and the Strata Corporation for the repair and replacement of the following:

- (i) any defect in the materials and labour for a period of 12 months;
- (ii) any defect in the common property, common facilities, and other assets of the Strata Corporation for a period of 15 months;
- (iii) any defect in the materials and labour supplied for the electrical, plumbing, heating, ventilation, air-conditioning, delivery, and distribution systems for a period of 24 months;
- (iv) any defect in the materials and labour supplied for the exterior cladding, caulking, windows, and doors that may lead to detachment or material damage to the new home for a period of 24 months;
- (v) any defect in materials and labour which renders the home unfit to live in for a period of 24 months;
- (vi) for a period of 24 months, any building code defect, which means an instance of non-compliance with the Building Code applicable to the Development if that non-compliance constitutes an unreasonable health or safety risk or has resulted in, or is likely to result in, material damage to the Development;

- (vii) for a period of 5 years, any building envelope defect, which means a defect that results in unintended water leakage from the exterior through the building envelope such that it causes, or is likely to cause, damage to the Development; and
- (viii) any structural defect for a period of 10 years.

5.3 Previously Occupied Building

The Development is not a previously occupied building or a building that was constructed 5 years before the filing of this Disclosure Statement.

6. **APPROVALS AND FINANCES**

6.1 Development Approval

Preliminary Layout Approval for the subdivision and consolidation of the Property to create the Parent Parcel was granted the City of Revelstoke on April 11, 2024, under file SUB2023-016 (as amended) and Preliminary Layout Approval for subdivision of the Parent Parcel to create the Development Property was granted by the City of Revelstoke on February 24, 2025, under file SUB2023-015 (as amended). Building Permits for the Strata Lots contained within Phases 1 and 2 of the Development have been issued by the City of Revelstoke under permit numbers BP2025-053 and BP2025-065, respectively. For the Strata Lots contained within Phases 3 & 4, the Developer has received a permit from the City of Revelstoke under number 2024-022 (as amended) that authorizes the excavation and construction of services on the Development Property. As the next step in the permitting process, the Developer has made application to the City of Revelstoke for issuance of a full building permit to construct the buildings and Strata Lots that comprise Phases 3 & 4 of the Development.

6.2 Construction Financing

All costs for construction of the Development will be paid for, in full, from the Developer's own funds.

7. **MISCELLANEOUS**

7.1 Deposits

All deposits and other monies received shall be held in trust by the law firm of Pushor Mitchell LLP in the manner required by the Real Estate Development Marketing Act.

The Developer has not entered into a deposit protection contract and does not maintain deposit protection insurance but may put deposit insurance in place at a later date.

7.2 Purchase Agreement

- (a) The Developer (in this section also referred to the "Seller") will use the form of Contract of Purchase and Sale substantially in the form attached hereto as Schedule "J" (the "Contract"). The Developer and the Purchaser are at liberty to negotiate the terms of the Contract.

- (b) The Contract contains the following provisions allowing either the Seller or Purchaser to terminate the Contract:

Purchaser's Condition (if any)	If the Purchaser does not give notice of waiver or satisfaction of the Purchaser's Condition on or before the date specified, and failing further agreement between the parties, the Contract is terminated and of no further force or effect between the parties
Section 2(b)	Barring any other agreement between the Seller and the Purchaser, the Purchaser may terminate the contract if the Seller extends the Outside Completion Date pursuant to section 2(b) of Schedule A for a period of more than 6 months
Section 17	The Seller may terminate the Contract if the Purchaser fails to comply with the terms of the Contract

- (c) The Contract contains, at section 2 of Schedule A, a provision allowing for an extension by the Seller of the completion date should the Seller be unable to complete due to delays caused by matters out of the Vendor's direct control such as a strike, lock out, labour disputes, Acts of God, soil conditions, material shortage, labour shortage, or epidemic/pandemic as determined by the local health authority. There is no provision for the Purchaser to refuse such an extension.
- (d) The Contract contains, at section 23 of Schedule A, the terms on which a Purchaser may assign the Contract to a related individual or a third party.

Without the Developer's prior consent, any assignment of a Contract is prohibited. Consent to an assignment may be unreasonably withheld by the Developer in the Developer's sole discretion.

An assignment under the *Real Estate Development Marketing Act* is a transfer of some or all of the rights, obligations and benefits under a Contract made in respect of a strata lot in a development property, whether the transfer is made by the Purchaser under the Contract to another person or is a subsequent transfer.

Each proposed party to an assignment agreement must provide the Developer with the information and records required under the *Real Estate Development Marketing Act*.

Before the Developer consents to an assignment of a Contract, the Developer will be required to collect information and records under the *Real Estate Development Marketing Act* from each proposed party to an assignment agreement, including personal information, respecting the following:

- (i) the party's identity;
- (ii) the party's contact and business information;
- (iii) the terms of the assignment agreement.

Information and records collected by the Developer must be reported by the Developer to the administrator designated under the *Property Transfer Tax Act*. The information and records may only be used or disclosed for tax purposes and other purposes authorized by section 20.5 of the *Real Estate Development Marketing Act*, which includes disclosure to the Canada Revenue Agency.

An assignment fee equal to 2.5% of the purchase price, plus GST and an administration fee of \$2,000.00, plus GST, is payable by the Purchaser under the assignment agreement to the Developer as a condition of assignment of the Contract. In the event the assignee is the purchaser's spouse, sibling, parent, grandparent, child or grandchild, or a company solely controlled by the purchaser, then the assignment fee shall be waived, but an administration fee of \$750.00, plus GST, will be required to be paid to the Developer.

- (e) There is no provision in the Contract for the Purchaser or Developer to receive interest on deposit monies.
- (f) Section 18 of the Contract permits the delivery of notices, amendments to Disclosure Statement and/or consolidated Disclosure Statements by prepaid mail, delivery by hand, transmittal by telecopy or email.

7.3 Developer's Commitments

The Developer has not made any commitments after completion of sales.

7.4 Other Material Facts

(a) Individual Lot Taxes

Each Strata Lot owner shall be responsible for real property taxes for his/her strata lot as assessed by the city. Property taxes are levied by, and payable to, the City of Revelstoke.

(b) Fire and Liability Insurance

Each Strata Lot owner will be responsible for insuring personal property and third party liability within his or her own Strata Lot once the transfer of such Strata Lot from the Developer is completed.

(c) Individual Lot Expenses

The following utilities will be separately metered or assessed to each Strata Lot and are the responsibility of each Strata Lot owner:

- (i) Electricity
- (ii) Cablevision
- (iii) Telephone
- (iv) Internet Service
- (v) Water and Sewer Services
- (vi) Geothermal Heating and Cooling
- (vii) Propane Service

(d) Strata Corporation Expenses

All maintenance and utilities costs relating to the common property and the Common Lot (See section 3.9(f) of this Disclosure Statement) are paid by the Strata Corporation and their cost will be prorated to the owners of the Strata Lots and included in the monthly strata fees as set out in the strata corporation budget attached hereto as Schedule "F".

(g) Other Contracts Affecting the Development

The Developer has not entered into any agreements with respect to the Development other than the agreements described herein. When appropriate to do so, the Developer intends to enter into, or to cause the Strata Corporation to enter into or to assume, some or all of the following agreements:

- (i) agreements the Developer believes are for the benefit of the Strata Corporation and the Development in general;
- (ii) utilities and other service agreements referred to in section 3.9;
- (iii) landscaping and gardening maintenance agreement;
- (iv) snow removal and de-icing services agreement;
- (v) agreement(s) with respect to cleaning, maintenance and/or repair of some or all of the common property, common facilities and/or other assets of the Strata Corporation.

DEEMED RELIANCE

SECTION 22 OF THE REAL ESTATE DEVELOPMENT MARKETING ACT PROVIDES THAT EVERY PURCHASER WHO IS ENTITLED TO RECEIVE THIS DISCLOSURE STATEMENT IS DEEMED TO HAVE RELIED ON ANY FALSE OR MISLEADING STATEMENT OF A MATERIAL FACT CONTAINED IN THIS DISCLOSURE STATEMENT, IF ANY, AND ANY OMISSION TO STATE A MATERIAL FACT. THE DEVELOPER, ITS DIRECTORS AND ANY PERSON WHO HAS SIGNED OR AUTHORIZED THE FILING OF THIS DISCLOSURE STATEMENT ARE LIABLE TO COMPENSATE THE PURCHASER FOR ANY MISREPRESENTATION, SUBJECT TO ANY DEFENCES AVAILABLE UNDER SECTION 22 OF THE ACT.

DECLARATION

THE FOREGOING STATEMENTS DISCLOSE, WITHOUT MISREPRESENTATION, ALL MATERIAL FACTS RELATING TO THE DEVELOPMENT REFERRED TO ABOVE, AS REQUIRED BY THE REAL ESTATE DEVELOPMENT MARKETING ACT OF BRITISH COLUMBIA, AS OF APRIL 2, 2026.

Northland Properties Corporation

Per:



Authorized Signatory

Signed by the Director in his personal capacity:



Robert Thomas Gaglardi

Schedule "A"
Draft Strata Plan

Plan to Accompany a Disclosure Statement on Lot 2, Sec 23, Tp 23, Rge 2, W6M, KD, Plan EPP_____

City of Revelstoke
BCGS No. 82L.100
SCALE 1:1000

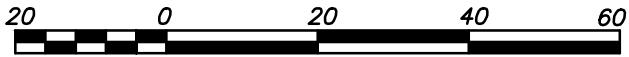

ALL DISTANCES SHOWN IN METRES AND DECIMALS THEREOF

THE INTENDED PLOT SIZE OF THIS PLAN IS 280mm IN WIDTH x
432mm IN HEIGHT (B size) WHEN PLOTTED AT A SCALE OF 1:1000

Nichol Road

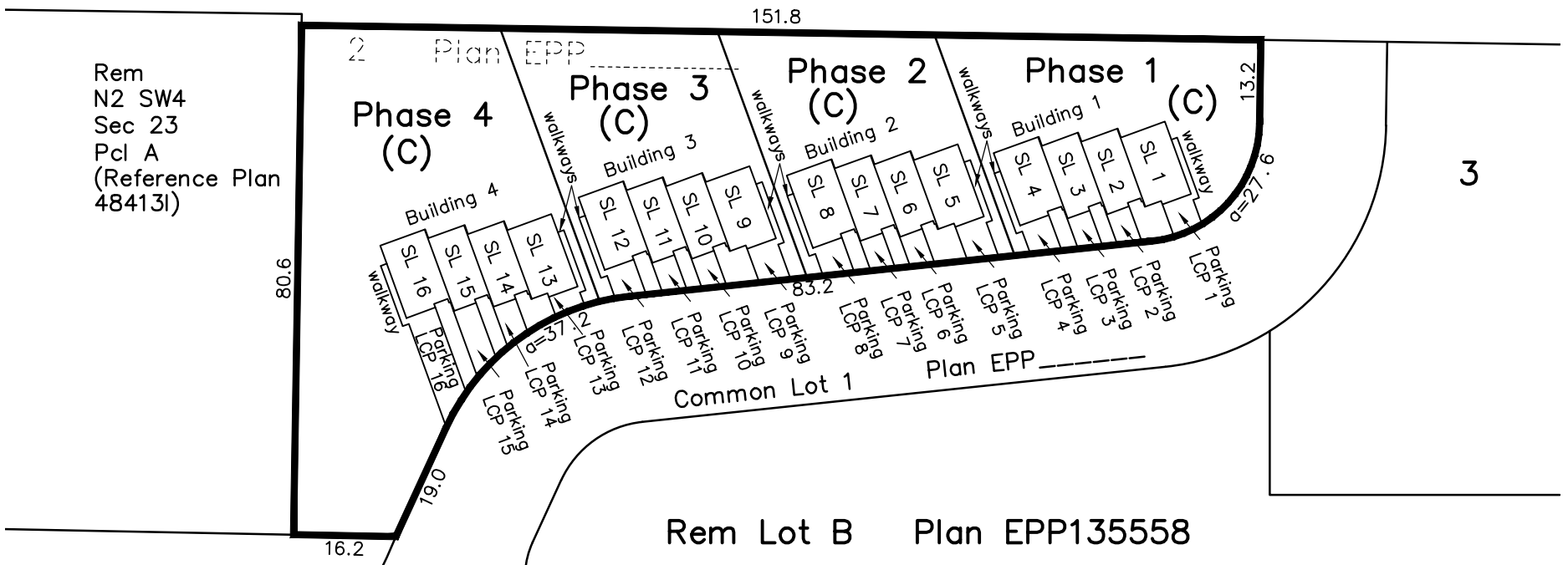

Rem
N2 SW4
Sec 23
Pcl A
(Reference Plan
484131)

Rem Lot B Plan EPP135558

4
Plan EPP_____

NOTE:
LOT 2 PLAN EPP_____ (THIS DEVELOPMENT) HAS A
1/78 INTEREST IN COMMON LOT 1 PLAN EPP_____

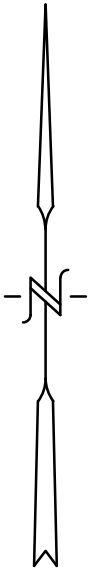

LEGEND

BEARINGS ARE GRID, AND ARE DERIVED FROM GPS OBSERVATIONS.

- SL DENOTES STRATA LOT
- Pt DENOTES PART
- (C) DENOTES COMMON PROPERTY

THIS PLAN LIES WITHIN THE REGIONAL DISTRICT OF
COLUMBIA SHUSWAP

CERTIFIED CORRECT THIS 28th DAY OF MARCH, 2025.

J.R. SHORTT, BCLS #770

russell shortt
land SURVEYORS
2801-32nd Street, Vernon, B.C. V1T 5L8
Phone: (250)545-0511 Email: jasons@jrshortt.ca
FILE: 30731 ds 2

Strata Lots 1-4 Building 1

SCALE 1:250



ALL DISTANCES SHOWN IN METRES AND DECIMALS THEREOF

THE INTENDED PLOT SIZE OF THIS PLAN IS 280mm IN WIDTH x 432mm IN HEIGHT (B size) WHEN PLOTTED AT A SCALE OF 1:250

Third Floor

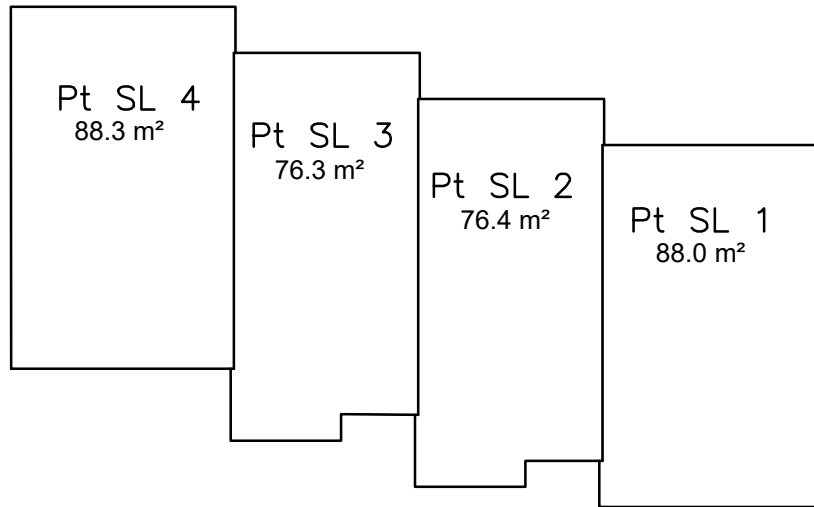

Second Floor

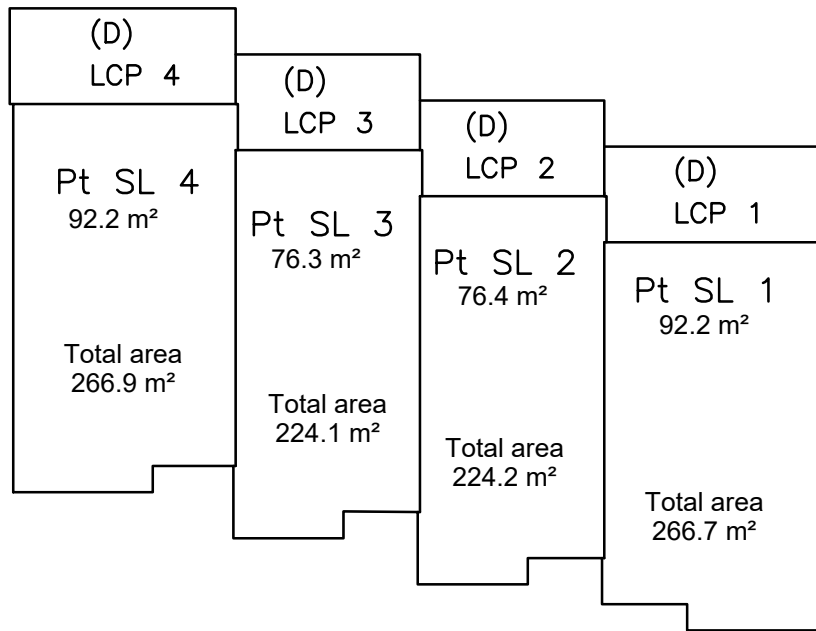

First Floor

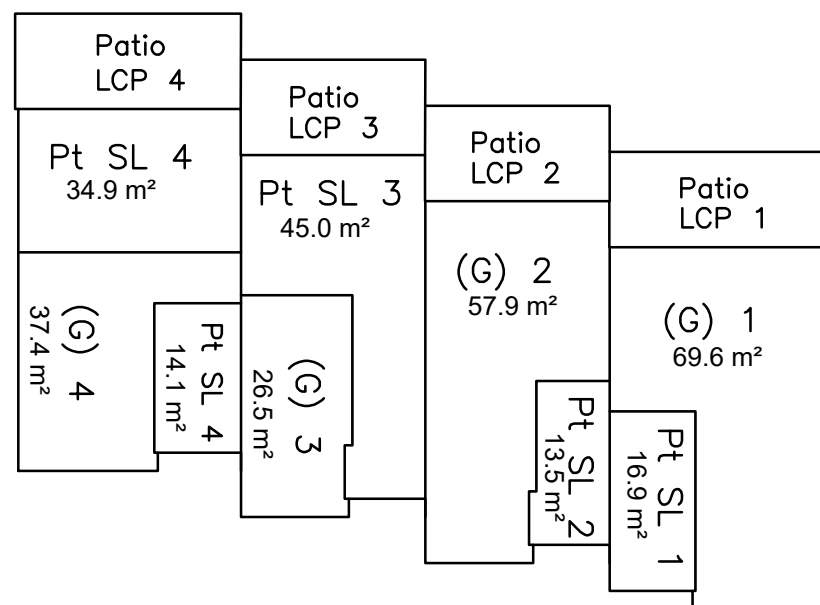

THIS SHEET SHOWS AREAS TO THE CENTRELINE OF ALL WALLS.

LEGEND

BEARINGS ARE GRID, AND ARE DERIVED FROM GPS OBSERVATIONS.

SL DENOTES STRATA LOT

Pt DENOTES PART

(G) DENOTES GARAGE PART OF STRATA LOT

(C) DENOTES COMMON PROPERTY

(D) DENOTES DECK

LCP DENOTES LIMITED COMMON PROPERTY FOR STRATA LOT

HA DENOTES HABITABLE AREA

russell shortt

land SURVEYORS

2801-32nd Street, Vernon, B.C. V1T 5L8

Phone: (250)545-0511

Email: jasons@jrshortt.ca

FILE: 30731 ds 17

Strata Lots 5-8 Building 2

SCALE 1:250

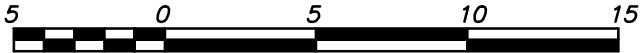

ALL DISTANCES SHOWN IN METRES AND DECIMALS THEREOF

THE INTENDED PLOT SIZE OF THIS PLAN IS 280mm IN WIDTH x 432mm IN HEIGHT (B size) WHEN PLOTTED AT A SCALE OF 1:250

Third Floor

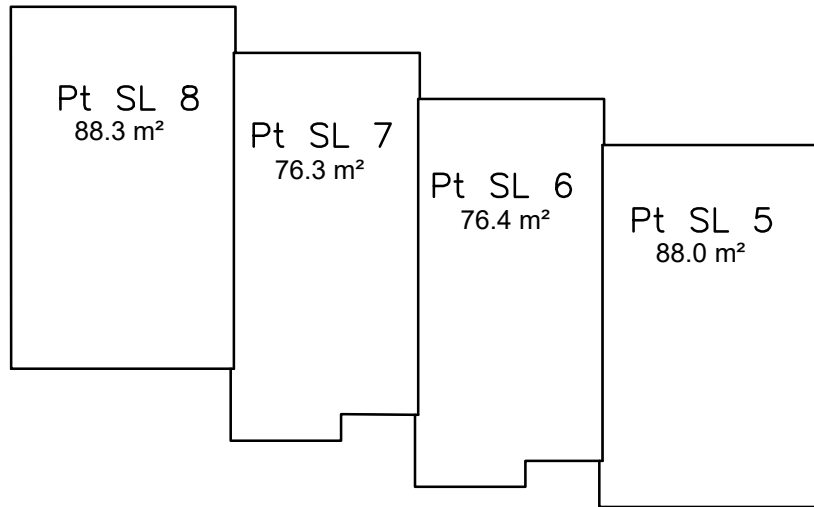

Second Floor

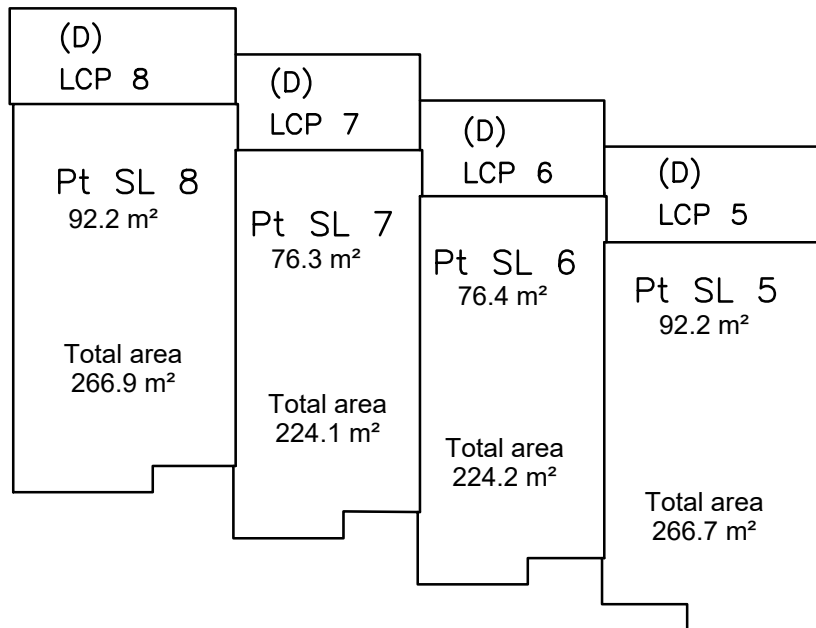

First Floor

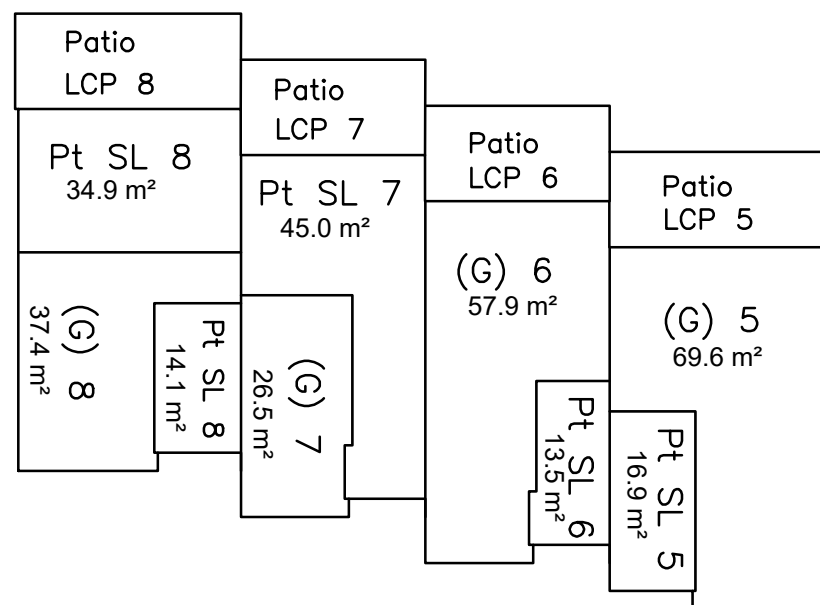

THIS SHEET SHOWS AREAS TO THE CENTRELINE OF ALL WALLS.

LEGEND

BEARINGS ARE GRID, AND ARE DERIVED FROM GPS OBSERVATIONS.

SL DENOTES STRATA LOT

Pt DENOTES PART

(G) DENOTES GARAGE PART OF STRATA LOT

(C) DENOTES COMMON PROPERTY

(D) DENOTES DECK

LCP DENOTES LIMITED COMMON PROPERTY FOR STRATA LOT

HA DENOTES HABITABLE AREA

russell shortt

land SURVEYORS

2801-32nd Street, Vernon, B.C. V1T 5L8

Phone: (250)545-0511

Email: jasons@jrshortt.ca

FILE: 30731 ds 17

Strata Lots 9-12 Building 3

SCALE 1:250

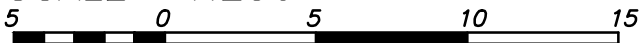

ALL DISTANCES SHOWN IN METRES AND DECIMALS THEREOF

THE INTENDED PLOT SIZE OF THIS PLAN IS 280mm IN WIDTH x 432mm IN HEIGHT (B size) WHEN PLOTTED AT A SCALE OF 1:250

Third Floor

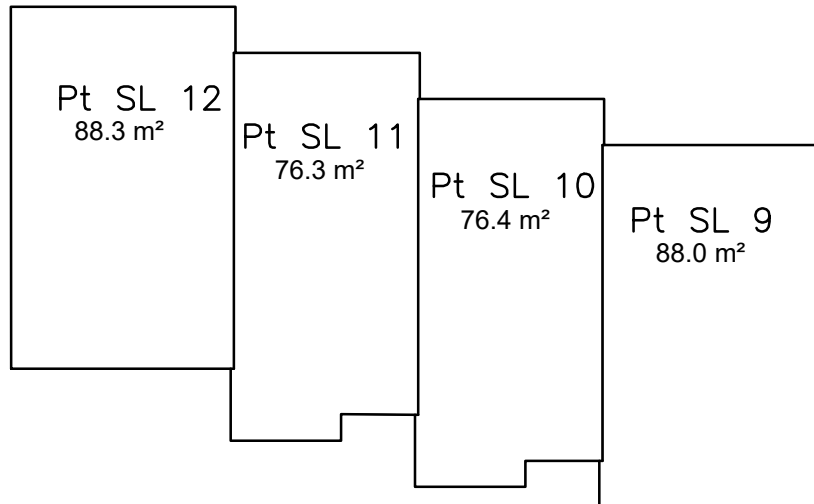

Second Floor

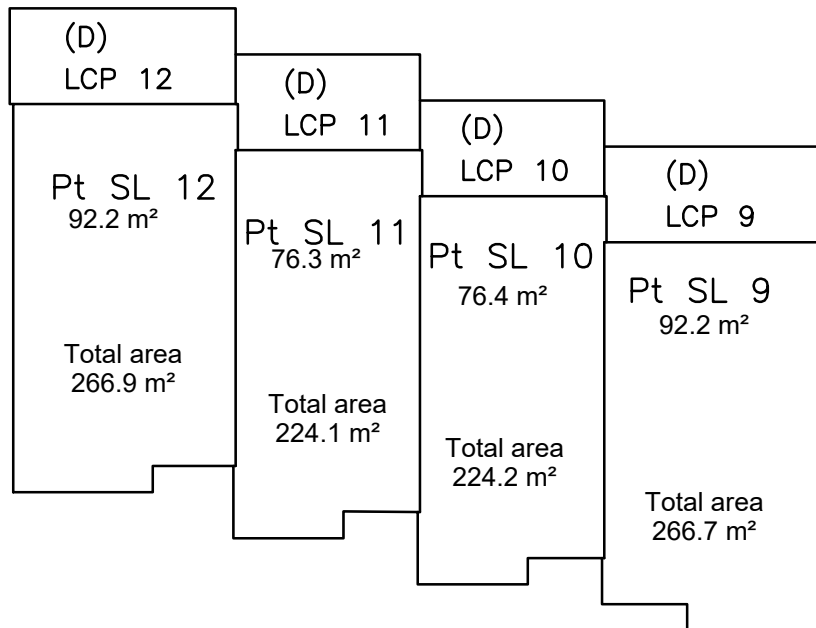

First Floor

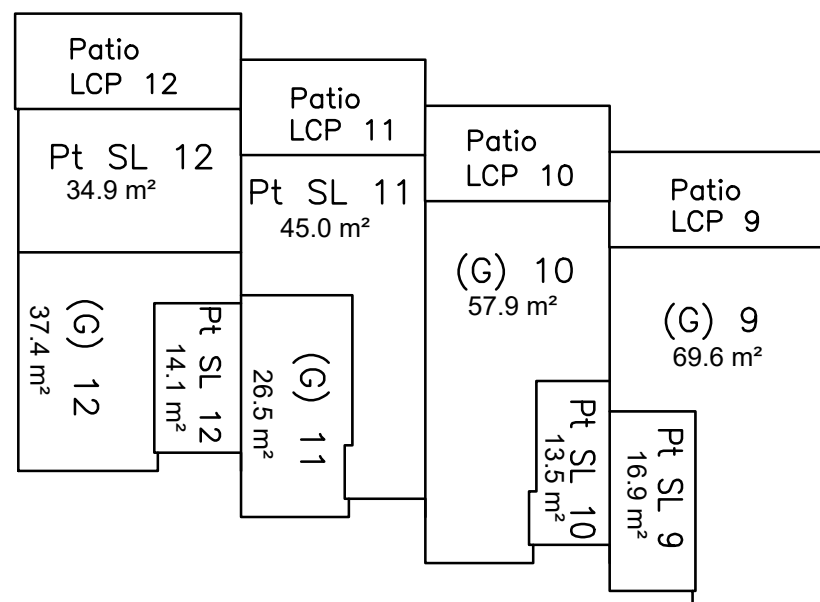

THIS SHEET SHOWS AREAS TO THE CENTRELINE OF ALL WALLS.

LEGEND

BEARINGS ARE GRID, AND ARE DERIVED FROM GPS OBSERVATIONS.

SL DENOTES STRATA LOT

Pt DENOTES PART

(G) DENOTES GARAGE PART OF STRATA LOT

(C) DENOTES COMMON PROPERTY

(D) DENOTES DECK

LCP DENOTES LIMITED COMMON PROPERTY FOR STRATA LOT

HA DENOTES HABITABLE AREA

russell shortt

land SURVEYORS

2801-32nd Street, Vernon, B.C. V1T 5L8

Phone: (250)545-0511

Email: jasons@jrshortt.ca

FILE: 30731 ds 17

Strata Lots 13-16 Building 4

SCALE 1:250



ALL DISTANCES SHOWN IN METRES AND DECIMALS THEREOF

THE INTENDED PLOT SIZE OF THIS PLAN IS 280mm IN WIDTH x 432mm IN HEIGHT (B size) WHEN PLOTTED AT A SCALE OF 1:250

Third Floor

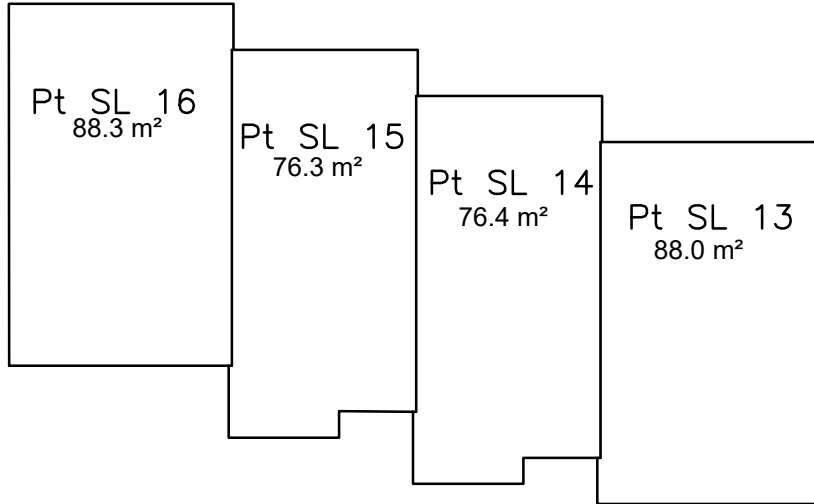

Second Floor

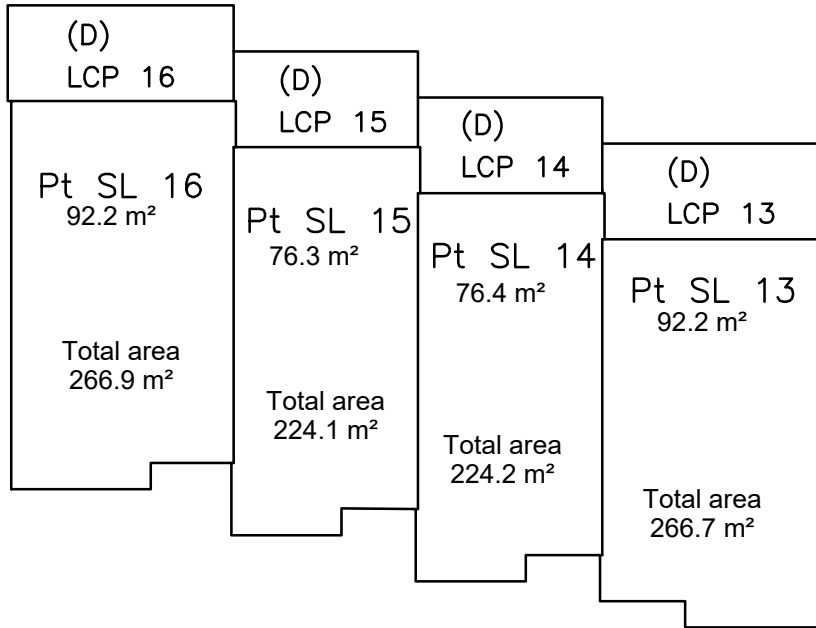

First Floor

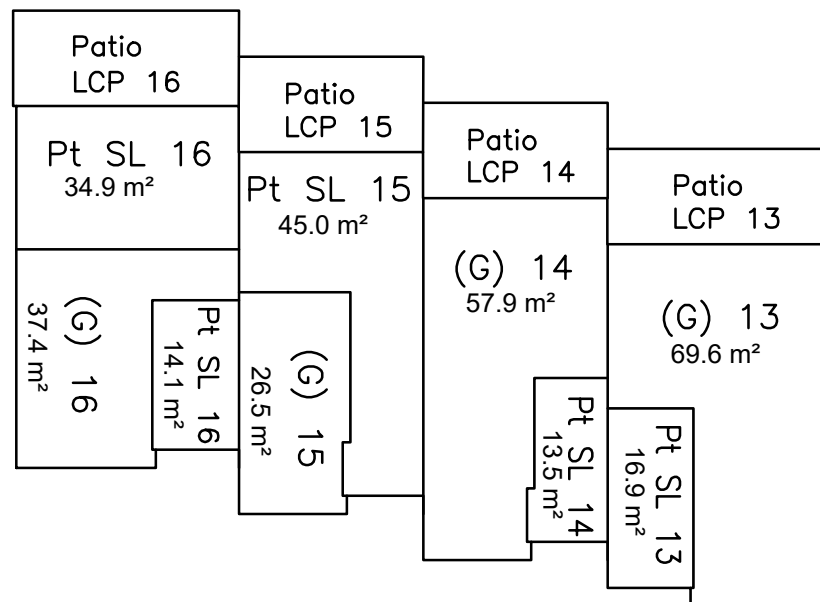

THIS SHEET SHOWS AREAS TO THE CENTRELINE OF ALL WALLS.

LEGEND

BEARINGS ARE GRID, AND ARE DERIVED FROM GPS OBSERVATIONS.

SL DENOTES STRATA LOT

Pt DENOTES PART

(G) DENOTES GARAGE PART OF STRATA LOT

(C) DENOTES COMMON PROPERTY

(D) DENOTES DECK

LCP DENOTES LIMITED COMMON PROPERTY FOR STRATA LOT

HA DENOTES HABITABLE AREA

russell shortt

land SURVEYORS

2801-32nd Street, Vernon, B.C. V1T 5L8

Phone: (250)545-0511

Email: jasons@jrshortt.ca

FILE: 30731 ds 17

Schedule "B"
Zoning Bylaw

10.2 Comprehensive Development Zone 2 (CD-02)

10.2.1 Purpose

The purpose of this zone is to provide for a year-round, multi purpose destination recreational resort. In addition to zoning, parking, *landscaping*, and *screening* regulations, this Section contains guidelines for the issuance of Development Permits.

10.2.2 Permitted Uses (*Resort Neighbourhood – Areas 2, 3, 4, 5, 6, 7, 8 as shown on [CD-02 Schedule A](#)*)

Principal Uses:

- (1) *Café*
- (2) *Convenience store*
- (3) *Dwelling, multi-unit*
- (4) *Dwelling, single-detached*
- (5) *Dwelling, two-unit*
- (6) *Emergency and protective services*
- (7) *Golf course*
- (8) *Indoor participant recreation services*
- (9) *Mixed-use building*
- (10) *Outdoor participant recreation services*
- (11) *Restaurant, dine-in*
- (12) *Tourist accommodation*

Accessory Uses:

- (13) *Accessory building*
- (14) *Accessory dwelling unit*
- (15) *Accessory use*
- (16) *Bed and breakfast*
- (17) *Home based business, type I*
- (18) *Long term rental*
- (19) *Short term rental*

Section 1: Administration and Enforcement	Section 2: Interpretation	Section 3: Definitions	Section 4: General Regulations	Section 5: Use-Specific Regulations	Section 6: Residential (R) Zones
Section 7: Mixed Use (MU) and Commercial (C) Zones	Section 8: Industrial (I) Zones	Section 9: Environment and Rural Recreation (E) / Public Use (P) Zones	Section 10: Comprehensive Development (CD) Zones	Section 11: Off-Street Parking Regulations	Section 12: Off-Street Loading Regulations

10.2.3 Permitted Uses (*Resort Core – Areas 1, 9, 10 as shown on [CD-02 Schedule A](#)*)

Principal Uses:

- (1) *Automotive repair services, light*

- (2) *Automotive repair services, heavy*

- (3) *Café*

- (4) *Convenience store*

- (5) *Dwelling, multi-unit*

- (6) *Dwelling, single-detached*

- (7) *Dwelling, two-unit*

- (8) *Emergency and protective services*

- (9) *Equipment sales, rental, and repair services, light*

- (10) *Golf course*

- (11) *Indoor participant recreation services*

- (12) *Information centre*

- (13) *Liquor store*

- (14) *Mixed-use building*

- (15) *Neighbourhood pub*

- (16) *Office*

- (17) *Outdoor participant recreation services*

- (18) *Personal service establishment*

- (19) *Professional service establishment*

- (20) *Public parking area*

- (21) *Restaurant, dine-in*

- (22) *Retail store (with a maximum usable floor space of 1,000.0 sq. m per premise)*

- (23) *Retail store, grocery*

- (24) *Tourist accommodation*

Accessory Uses:

- (25) *Accessory building*

- (26) *Accessory dwelling unit*

- (27) *Accessory use*

Section 1: Administration and Enforcement	Section 2: Interpretation	Section 3: Definitions	Section 4: General Regulations	Section 5: Use-Specific Regulations	Section 6: Residential (R) Zones
Section 7: Mixed Use (MU) and Commercial (C) Zones	Section 8: Industrial (I) Zones	Section 9: Environment and Rural Recreation (E) / Public Use (P) Zones	Section 10: Comprehensive Development (CD) Zones	Section 11: Off-Street Parking Regulations	Section 12: Off-Street Loading Regulations

(28) *Bed and breakfast*

(29) *Home based business, type I*

(30) *Long term rental*

(31) *Short term rental*

10.2.4 Density Regulations

- (1) The number of square metres of commercial floor area (which for certainty excludes *tourist accommodation* units) in each Area of the CD-02 zone shown on [CD-02 Schedule A](#) shall not exceed the total number specified in column 7 of Table 1 as shown in [Section 10.2.5](#).
- Notwithstanding [Section 10.2.4\(1\)](#), up to 30% of the total commercial area (6,688.0 sq. m) allocated to Area 1 may be transferred to Area 2, 3, 4, 5, 8 or 9 without an amendment to this Bylaw. No more than 15% of commercial area (3,344.0 sq. m) may be transferred to any single Area, except within that portion of Area 5 as more particularly shown on [CD-02 Schedule B](#), where no more than 5% of commercial area (1,114.0 sq. m) may be transferred from Area 1.
 - With any transfer of density out of Area 1, a covenant shall be registered on title of the parent *lot(s)* within Area 1 specifying the amount of density that has been transferred and to what area. This covenant shall be updated with any subsequent density transfers out of Area 1.
 - Any transfer of density must be in alignment with the Master Development Agreement between the Province of British Columbia and the primary resort developer who is signatory to the agreement.
-
- (2) The number of *tourist accommodation* units and *dwelling units* in the form of *multi-unit dwellings*, *two-unit dwellings*, or *single-detached dwellings* in each Area of the CD-02 zone shown on [CD-02 Schedule A](#) shall not exceed the total number specified in column 7 of Table 1 as shown in [Section 10.2.5](#).
- Notwithstanding [Section 10.2.4\(2\)](#), up to 30% (822 units) of the total units allocated to Area 1 may be transferred to Area 2, 3, 4, 5, 8 or 9 without an amendment to this Bylaw. No more than 15% (411 units) may be transferred to any single Area.
 - No transfer of *tourist accommodation* units is permitted in that portion of Area 5 as more particularly shown in [CD-02 Schedule B](#).
 - With any transfer of density out of Area 1, a covenant shall be registered on title of the parent *lot(s)* within Area 1 specifying the amount of density that has been transferred and to what area. This covenant shall be updated with any subsequent density transfers out of Area 1.
 - Any transfer of density must be in alignment with the Master Development Agreement between the Province of British Columbia and the primary resort developer who is signatory to the agreement.
-

Section 1: Administration and Enforcement	Section 2: Interpretation	Section 3: Definitions	Section 4: General Regulations	Section 5: Use-Specific Regulations	Section 6: Residential (R) Zones
Section 7: Mixed Use (MU) and Commercial (C) Zones	Section 8: Industrial (I) Zones	Section 9: Environment and Rural Recreation (E) / Public Use (P) Zones	Section 10: Comprehensive Development (CD) Zones	Section 11: Off-Street Parking Regulations	Section 12: Off-Street Loading Regulations

- (3) The density permitted in this Section is a maximum. In the event that the presence of environmentally sensitive areas, including but not limited to those identified in the Official Community Plan, steep slopes or other physical constraints make the *development* of any Area to the maximum permitted density impossible, notwithstanding any transfers of density as may be permitted by this Bylaw, the maximum permitted density of that Area is the density as so constrained.
-
- (4) The owner may, for the purpose of applying the density restrictions in this Section:
- a. Substitute permitted *multi-unit dwelling* and *single-detached dwelling* uses for one another within the same Area, on the basis that one *multi-unit dwelling* (apartment) unit equals one *multi-unit dwelling* (row house) unit, and one *single-detached dwelling* unit equals 1.5 *multi-unit dwelling* units.
-
- (5) Prior to the approval of any subdivision of land in the zone, if this Bylaw has not been amended to establish the maximum density of *development* on each proposed *lot* of land in the zone, the owner must grant to the City of Revelstoke a covenant under s.219 of the Land Title Act establishing a maximum density of *development* on each new *lot* of land in the zone, such that the maximum permitted density of *development* permitted by covenant on all *lots* of land in the zone does not exceed that permitted by this Bylaw, and the obligation to provide *resort employee housing units* is distributed proportionately among the new *lots*.

10.2.5 Table 1 – Density Allowances

Area	Commercial Floor Area	Tourist Accommodation Units	Multi-unit Dwelling (Apartment) Units	Multi-unit Dwelling (Row House) and Two-Unit Dwelling Units	Single-Detached Dwelling Units	Total
1	22,295 sq. m	1,420	900	370	52	22,295 sq. m of commercial 2,742 units
2	0	0	0	30	37	67 units
3	1,450 sq. m	150	50	0	0	1,450 sq. m of commercial 200 units
4	0	0	10	0	0	10 units
5	0	0	0	20	20	40 units
6	0	0	0	45	20	65 units
7	0	150	0	35	0	185 units
8	0	0	0	205	180	385 units
9	0	150	50	50	20	270 units
10	8,450 sq. m	784	488	0	0	8,450 sq. m of commercial 1,272 units

Section 1: Administration and Enforcement	Section 2: Interpretation	Section 3: Definitions	Section 4: General Regulations	Section 5: Use-Specific Regulations	Section 6: Residential (R) Zones
Section 7: Mixed Use (MU) and Commercial (C) Zones	Section 8: Industrial (I) Zones	Section 9: Environment and Rural Recreation (E) / Public Use (P) Zones	Section 10: Comprehensive Development (CD) Zones	Section 11: Off-Street Parking Regulations	Section 12: Off-Street Loading Regulations

10.2.6 Employee Housing Requirements

- (1) Following the issuance of a Building Permit for the 1,200th *tourist accommodation* unit or *dwelling unit* in this zone, no owner of land in this zone shall be entitled to construct or occupy any *tourist accommodation* unit or *dwelling unit* in this zone unless the owner has provided a number of *resort employee housing units* equal to 10% of the number of *tourist accommodation* units or dwellings for which a Building Permit is sought.

- (2) In addition to the number of *resort employee housing units* required under [Section 10.2.6\(1\)](#), the owner must also provide a number of *resort employee housing units* equal to 10% of the number of *tourist accommodation* units and dwellings already constructed in the zone at the time the first application that is subject to [Section 10.2.6\(1\)](#) is made, by providing *resort employee housing units* at the rate of 15% of the number of *tourist accommodation* units or dwellings for which a Building Permit is sought, until the total number of *resort employee housing units* that have been provided is equal to 10% of the total number of *tourist accommodation* units or dwellings that have been constructed in this zone.

- (3) For the purposes of [Section 10.2.6\(1\)](#) and [Section 10.2.6\(2\)](#), the number of each type of *resort employee* housing unit provided must, in relation to each Building Permit issued, be proportional to the number of each type of unit for which the Building Permit is sought, with *multi-unit dwelling* employee housing units being provided in respect of *tourist accommodation* units proposed, except that the owner may propose a different combination of employee housing units for the approval of the municipality on the basis of the municipality’s assessment of the demand for employee housing units at the time the Building Permit application is made. The number of each type of *resort employee* housing unit provided must, at the time that the lands in this zone are developed to the maximum extent specified in the third, fourth, fifth and sixth columns of Table 1 in [Section 10.2.5](#), be proportional to the number of each type of unit specified in Table 1 in [Section 10.2.5](#), except that *multi-unit dwelling* (apartment) employee housing units must be provided in respect of *tourist accommodation* units proposed.

- (4) For the purposes of [Section 10.2.6\(1\)](#) and [Section 10.2.6\(2\)](#), a *resort employee* housing unit is deemed to have been provided if, at the time the Building Permit in question is issued:
 - a. An existing *dwelling unit* in the City of Revelstoke has been designated by the owner as a *resort employee* housing unit and the *dwelling unit* is subject to a covenant and housing agreement; or
 - b. The Building Permit authorizes the construction of one or more *resort employee* housing units as part of the *building* authorized by the permit, the owner has designated the *resort employee* housing units in the *building* and granted a covenant to the City of Revelstoke prohibiting the occupancy of the *building* until the number of *resort employee housing units* required under this Section in relation to the *building* are completed and ready to occupy, and the *resort employee housing units* are subject to a covenant and housing agreement.

Section 1: Administration and Enforcement	Section 2: Interpretation	Section 3: Definitions	Section 4: General Regulations	Section 5: Use-Specific Regulations	Section 6: Residential (R) Zones
Section 7: Mixed Use (MU) and Commercial (C) Zones	Section 8: Industrial (I) Zones	Section 9: Environment and Rural Recreation (E) / Public Use (P) Zones	Section 10: Comprehensive Development (CD) Zones	Section 11: Off-Street Parking Regulations	Section 12: Off-Street Loading Regulations

10.2.7 Site Servicing

- (1) Development Permits may include requirements for emergency vehicle access and water supply for interface fire suppression, if recommended by the Fire Chief on the basis of generally accepted interface fire hazard management practices.

10.2.8 Maximum Building Height

<u>Regulation</u>	<u>Requirement</u>
(1) <i>Tourist accommodation</i>	8 storeys
(2) <i>Multi-unit dwelling (apartment) / mixed-use building</i>	8 storeys
(3) <i>Single-detached dwelling, multi-unit dwelling (row house), two-unit dwelling, and non-residential buildings</i>	12.0 m
(4) Whether or not a height regulation is specified, <i>building height</i> regulations may be varied or supplemented by Development Permit conditions for the purpose of: <ul style="list-style-type: none"> a. Ensuring that fire suppression for each <i>building</i> is within the capability of the Revelstoke Fire Department. b. Protecting and enhancing views of and from the <i>building</i> in question and other <i>buildings</i> in the vicinity. c. Enhancing views of the Revelstoke Mountain Resort and adjacent natural areas that are visible from the <i>City</i>. d. Ensuring that pedestrian scale in adjacent <i>street</i> and public areas is not lost. 	

10.2.9 Siting of Buildings

- (1) The minimum depth and width of yards and maximum *lot coverage (building)* are not specified in this zone.
- (2) Whether or not a siting or *lot coverage (building)* regulation is specified, these regulations may be varied or supplemented by Development Permit conditions for the purpose of:
 - a. Optimizing the siting of a *building* on a *lot* having regard to the presence of natural features such as rock outcrops, environmentally sensitive areas and natural vegetation, and steep slopes.
 - b. Providing, in the case of commercial *development* adjacent to a *street*, a sense of enclosure for public areas on the *street*.
 - c. Ensuring a suitable amount of private open space on the *lot* as well as space for off-street parking.
 - d. Ensuring that pedestrian scale in adjacent *street* and public areas is not lost.
 - e. Maximizing privacy of *building* occupants in relation to the siting of other *buildings* and public areas in the vicinity.

Section 1: Administration and Enforcement	Section 2: Interpretation	Section 3: Definitions	Section 4: General Regulations	Section 5: Use-Specific Regulations	Section 6: Residential (R) Zones
Section 7: Mixed Use (MU) and Commercial (C) Zones	Section 8: Industrial (I) Zones	Section 9: Environment and Rural Recreation (E) / Public Use (P) Zones	Section 10: Comprehensive Development (CD) Zones	Section 11: Off-Street Parking Regulations	Section 12: Off-Street Loading Regulations

- f. Protecting *residential uses* from noise and other nuisance problems associated with *non-residential uses*.
- g. Minimizing the risk of wildfire spread from forest to *building* and from *building* to *building*.
- h. Providing for suitable snow shedding and snow storage areas; and
- i. Accommodating the recommendations of a qualified environmental professional with respect to the siting of *buildings* and *structures* in relation to riparian assessment areas.

-
- (3) Natural and man-made site features should be recognized and incorporated into the project design, including solar access, trees, topographic features, view corridors and environmentally sensitive areas and buffers.
-
- (4) The location and configuration of *buildings* should be established to provide privacy to surrounding dwellings through *setbacks*, *screening*, and orientation.
-
- (5) Site planning should provide for adequate separation between *uses* to mitigate or eliminate potential conflict issues. Mitigation may include orientation of *buildings* or *building* features such as entrances, window locations, *setbacks*, *screening*, limiting operation hours, design features such as window glazing or sound-proofing, or shielding of lighting to provide for privacy and reduction of noise and glare.
-
- (6) Publicly-used open spaces such as plazas, courtyards and green spaces should be provided in commercial and mixed-used *developments*.
-
- (7) Useable private and common open space should be provided for *multi-unit dwelling residential uses*.
-
- (8) All *buildings* should be accessible to and integrated with an onsite pedestrian circulation system.
-
- (9) Adequate areas should be provided for snow storage and utility requirements.
-
- (10) Service area *use* should not conflict with pedestrian and vehicular traffic.
-
- (11) Pedestrian paths should be connected to existing or planned trail networks.
-
- (12) Recreational trails should be designed to mitigate potential *use* conflicts and negative impacts on nearby residents, including noise pollution from snowmobiles, through site planning, *use* of buffers and trail use restrictions.
-
- (13) *Buildings* should be designed to keep pedestrian walkways or public areas and *building* entrances free from snow shed. Snow shed areas should be located in areas able to accommodate the snow accumulation and allow for periodic snow removal, but which do not impede access or visibility for pedestrian or vehicular flow.
-
- (14) Play areas and parks should be incorporated into multiple-unit dwelling neighbourhoods.
-
- (15) No *structures*, site furnishings or objects should be located as to inhibit snow removal, snow storage or pedestrian movement.
-

Section 1: Administration and Enforcement	Section 2: Interpretation	Section 3: Definitions	Section 4: General Regulations	Section 5: Use-Specific Regulations	Section 6: Residential (R) Zones
Section 7: Mixed Use (MU) and Commercial (C) Zones	Section 8: Industrial (I) Zones	Section 9: Environment and Rural Recreation (E) / Public Use (P) Zones	Section 10: Comprehensive Development (CD) Zones	Section 11: Off-Street Parking Regulations	Section 12: Off-Street Loading Regulations

10.2.10 Environmentally Sensitive Areas and Areas Subject to Slope Hazards

- (1) Development Permits may include conditions and requirements for the planting or retention of trees or other vegetation to preserve, protect, restore, or enhance fish habitat or riparian areas, if recommended by a qualified environmental professional in a report prepared under [Section 10.2.10\(2\)](#).

- (2) No *building* or *structure* may be sited within any riparian assessment area unless a qualified environmental professional has provided the assessment report and certification described in the Riparian Areas Protection Regulation and the owner implements the protection measures identified in the report, and for the purposes of this Section, the terms “riparian assessment area”, “qualified environmental professional” and “assessment report” shall have the meanings prescribed in the Regulation.

- (3) Development Permits may include conditions and requirements as they relate to construction activities and land alteration in proximity to Williamson Lake to ensure measures for environmental protection during all phases of *development* as may be recommended by a qualified environmental professional to minimize any impacts to sensitive environmental or ecological features.

- (4) Development Permits may include conditions and requirements as it relates to *development* in proximity to Williamson Lake to ensure appropriate pedestrian connectivity as per any approved *City* master plans when completed in accordance with the recommendations of a qualified environmental professional.

- (5) Areas identified in the Official Community Plan should be protected. Any *structures* within these areas should be built in a manner which ensures the preservation and protection of the natural resources identified within these areas.

- (6) Development Permits should include, as required, conditions and requirements for protection of slopes over 30% or unstable slopes from *development*, if recommended by a geotechnical engineer.

- (7) Steep slopes exposed during construction should be re-vegetated.

- (8) Contour lines should be provided for all site plans, with intervals no less than three metre.

- (9) Silt fencing should be provided between disturbed land and riparian areas and / or their buffers.

- (10) Any required buffer or area to be protected should be marked on site with highly visible construction fencing prior to any disturbance.

- (11) *Landscaping* adjacent to riparian areas or wetlands must be with plantings requiring no pesticide or herbicide use.

- (12) Grading plans with sediment and erosion control measures for all *development* must be submitted to the City of Revelstoke for prior to any ground disturbance.

Section 1: Administration and Enforcement	Section 2: Interpretation	Section 3: Definitions	Section 4: General Regulations	Section 5: Use-Specific Regulations	Section 6: Residential (R) Zones
Section 7: Mixed Use (MU) and Commercial (C) Zones	Section 8: Industrial (I) Zones	Section 9: Environment and Rural Recreation (E) / Public Use (P) Zones	Section 10: Comprehensive Development (CD) Zones	Section 11: Off-Street Parking Regulations	Section 12: Off-Street Loading Regulations

10.2.11 Off-Street Parking and Loading

- (1) The off-street parking regulations as contained in [Section 11](#) shall apply, except where otherwise noted within this Section.

- (2) The off-street loading regulations as contained in [Section 12](#) shall apply, except where otherwise noted within this Section.

- (3) *Public parking areas* provided in association with ski lifts and related facilities shall be divided into identifiable sub-areas through the use of *landscaping*, and elevation changes, and screened from view from adjacent public and residential areas by a *landscaping* screen or *landscaped* berm with a minimum height of 1.83 m. Curbing is not required for any permeable surface *public parking areas*.

- (4) Development Permit conditions may vary or supplement the parking regulations as contained in [Section 11](#) and this Section in relation to Areas other than Areas 1, 9 and 10 on [CD-02 Schedule A](#) for the purpose of:
 - a. Accommodating the recommendations of a Qualified Environmental Professional with respect to the siting of off-street parking and loading areas in relation to riparian assessment areas.
 - b. Acknowledging the complementary nature of land uses in particular *buildings* that may result in a reduced aggregate requirement for off-street *parking spaces*.
 - c. Acknowledging the extent to which resort users arrive at the resort by means of transportation other than motor vehicles and do not require off-street *parking spaces*.

- (5) A Development Permit may authorize the use of permeable surfaces for off-street *parking areas* when it is developed in a manner to promote low impact *development*, enhanced infiltration and stormwater management, reduction of green house gas emissions, or to enhance the appearance of a *parking area*.

- (6) Parking should be placed beneath and / or behind *buildings* to the maximum extent possible.

- (7) Any *parking areas* visible from the *street* or publicly used open spaces should be *landscaped*.

- (8) *Landscaping* should be incorporated into parking *lot* design and used to define traffic circulation patterns and to provide for snow storage areas.

- (9) Surface *parking areas* should be screened from pedestrian and vehicular traffic.

- (10) Notwithstanding [Section 10.2.11\(1\)](#), minimum *parking space* requirements shall be in accordance with Table 2 as shown in [Section 10.2.12](#).

Section 1: Administration and Enforcement	Section 2: Interpretation	Section 3: Definitions	Section 4: General Regulations	Section 5: Use-Specific Regulations	Section 6: Residential (R) Zones
Section 7: Mixed Use (MU) and Commercial (C) Zones	Section 8: Industrial (I) Zones	Section 9: Environment and Rural Recreation (E) / Public Use (P) Zones	Section 10: Comprehensive Development (CD) Zones	Section 11: Off-Street Parking Regulations	Section 12: Off-Street Loading Regulations

10.2.12 Table 2 – Minimum Parking Requirements

Use	Number of Parking Spaces
<i>Multi-unit dwelling</i>	Studio suite – 0.5 <i>parking spaces</i> per unit
	One bedroom – 1 <i>parking space</i> per unit
	Two bedroom – 1.5 <i>parking spaces</i> per unit
	Three or more bedroom – 2 <i>parking spaces</i> per unit
	10% of the total required <i>parking spaces</i> per <i>building</i> or row house <i>dwelling units</i> that share a <i>common wall</i> shall be provided as dedicated visitor parking.
<i>Dwelling units</i> used for resort employee housing	0.15 <i>parking spaces</i> per bed unit
<i>Tourist accommodation</i> units located within Resort Core neighbourhoods 1 and 9	0.5 <i>parking spaces</i> per unit
All <i>non-residential uses</i> within a 450.0 metres radius of the designated day use parking lot	0 <i>parking spaces</i>

10.2.13 Garbage, Recycling and Service Areas

- (1) Loading areas, garbage containers and recycling bins shall be screened from view by a *landscaping* screen, a solid decorative fence, or a combination of both to a minimum height of 2.5 m. The *screening* shall not include locking mechanisms or enclosure devices that prohibit access to bins or containers.
- (2) Service areas should be screened from view from *streets* or *buildings* to minimize visual impacts.
- (3) Centralized wildlife proof garbage, composting and *recycling depots* should be provided for commercial and *residential use*.
- (4) All trash or recycling receptacles and storage containers should be wildlife proof.

10.2.14 Landscaping

- (1) The general regulations as contained in [Section 4.10](#) for *landscaping* are not applicable for *development* within this zone.
- (2) Development Permits may include *landscaping* conditions and requirements for the protection of *development* from wildfire hazard and in particular:
 - a. Specify plant materials that may and may not be used and the locations where they may be used.
 - b. Require the removal of accumulations of woody fuel and the maintenance of forest interface areas free of woody fuel.
- (3) Trees adjacent to roads on private *lots* are encouraged, provided they do not cause safety problems for pedestrian or vehicular traffic, including emergency vehicles, and do not impede snow removal operations.
- (4) *Landscaping* provided should be sited appropriately to distance wildfire ‘fuel’ from *structures* or *buildings* and provided in a manner that mitigates potential fire hazards.

Section 1: Administration and Enforcement	Section 2: Interpretation	Section 3: Definitions	Section 4: General Regulations	Section 5: Use-Specific Regulations	Section 6: Residential (R) Zones
Section 7: Mixed Use (MU) and Commercial (C) Zones	Section 8: Industrial (I) Zones	Section 9: Environment and Rural Recreation (E) / Public Use (P) Zones	Section 10: Comprehensive Development (CD) Zones	Section 11: Off-Street Parking Regulations	Section 12: Off-Street Loading Regulations

10.2.15 Form and Character of Buildings and Neighbourhoods

- (1) *Building* forms should provide view corridors between *building* clusters.

- (2) *Buildings* should minimize the blocking of sunlight to areas used by the public including plazas, pedestrian walkways, and accessible open spaces.

- (3) Commercial and mixed-used *buildings* should be scaled to enhance outdoor spaces for pedestrian use and comfort. This may include distinct *building* bases, detailing at the ground level, giving scale to upper levels, and providing high-quality wall materials.

- (4) Rooflines with generous overhangs should be provided for weather protection.

- (5) Roofs should incorporate design interest features such as changes of height, dormers, or special architectural features to avoid uninterrupted or long horizontal roof forms.

- (6) Slight steps in *building* walls or changes in alignment, color or materials should be incorporated to provide variety in *building* character.

- (7) *Building* features such as balconies or decks should be complementary to the character and materials of the *building*.

- (8) Entrances should give character to the *building* by including careful detailing of moldings, frames, paneling and hardware.

- (9) *Building* entryways, lobbies, stairs, corridors, and exterior walkways should be designed to accommodate people wearing ski boots and carrying bulky equipment. Extra width, pedestrian access grades and more durable materials should be provided to accommodate skier traffic.

- (10) Entrances to *buildings* should be connected to *parking areas*, sidewalks and public areas in a manner that allows for wheelchair access.

- (11) Roof mounted mechanical equipment should be concealed from view and *screening* should be complementary to the overall *building* design.

- (12) Above grade equipment should be screened from view and located in areas of limited visibility to pedestrian or vehicular traffic.

- (13) All mechanical equipment areas and *structures* should be shown on drawings submitted for Development Permit approval.

- (14) Roof materials should be of Class A fire resistant materials.

- (15) Materials should be complementary to those of *abutting lots*.

- (16) Stone-faced walls, horizontal lap siding or vertical board and batten, heavy timber and easy-to-maintain materials should be used on *building* exteriors. Consideration should be given to fire-resistance of materials.

- (17) All materials and colours to be used must be submitted to the City of Revelstoke with the Development Permit application.

- (18) Colours should be colours found in the natural setting of the resort lands or compatible with such colours, which have low reflectivity and are combined in complementary compositions.

Section 1: Administration and Enforcement	Section 2: Interpretation	Section 3: Definitions	Section 4: General Regulations	Section 5: Use-Specific Regulations	Section 6: Residential (R) Zones
Section 7: Mixed Use (MU) and Commercial (C) Zones	Section 8: Industrial (I) Zones	Section 9: Environment and Rural Recreation (E) / Public Use (P) Zones	Section 10: Comprehensive Development (CD) Zones	Section 11: Off-Street Parking Regulations	Section 12: Off-Street Loading Regulations

- (19) Appropriate lighting should be provided to all entrances, arcades, passageways for safety and aesthetic quality.

- (20) Light fixtures attached to *buildings* should be reflected to enhance the architecture.

- (21) Exterior lighting should not project above the horizontal or onto *abutting lots* or *uses*.

- (22) All *streets*, *lanes*, pedestrian walkways, and *parking areas* should provide adequate illumination for safety and directional orientation.

- (23) All on-*building*, and *street* lighting should minimize ambient light pollution and should include hooded fixtures.

- (24) All *development* should adhere to initiatives provided in the Fire Smart Manual, including providing chimney spark-arrestors, fire-retardant roofing, fire-resistant siding, non-combustible or fire-resistant materials for balconies and decks, and the enclosure of undersides of decks or overhangs.

- (25) Commercial *use* signage should comply with the regulations set forth in the [City of Revelstoke Sign Bylaw](#), as amended from time to time.

- (26) Residential *use* signage should comply with the regulations set forth in the City of Revelstoke Sign Bylaw, as amended from time to time.

- (27) Internally lit signs are discouraged.

- (28) Lighting fixtures for signage should be aimed and shielded to minimize glare and should complement the *buildings* architectural detailing.

- (29) Commercial signage should be at a pedestrian scale.

- (30) A comprehensive sign plan must be submitted with the Development Permit application.

- (31) Commercial *use* signage should comply with the regulations set forth in the [City of Revelstoke Sign Bylaw](#), as amended from time to time.

10.2.16 Other Conditions of Use

Accessory Buildings

- (1) The use-specific regulations as contained in [Section 5.1](#) shall apply to all *accessory buildings*.

Accessory Dwelling Units

- (2) The use-specific regulations as contained in [Section 5.2](#) shall apply to *accessory dwelling units* in this zone.

Bed and Breakfast

- (3) The use-specific regulations as contained in [Section 5.5](#) shall apply to all *bed and breakfasts*.

Section 1: Administration and Enforcement	Section 2: Interpretation	Section 3: Definitions	Section 4: General Regulations	Section 5: Use-Specific Regulations	Section 6: Residential (R) Zones
Section 7: Mixed Use (MU) and Commercial (C) Zones	Section 8: Industrial (I) Zones	Section 9: Environment and Rural Recreation (E) / Public Use (P) Zones	Section 10: Comprehensive Development (CD) Zones	Section 11: Off-Street Parking Regulations	Section 12: Off-Street Loading Regulations

Beekeeping (Apiculture)

(4) The use-specific regulations as contained in [Section 5.4](#) apply to all beekeeping.

Building Height Exemptions

(5) The general regulations as contained in [Section 4.2](#) apply to all *buildings* with respect to exemptions to the maximum *building height*.

Home Based Businesses

(6) The use-specific regulations as contained in [Section 5.9](#) shall apply to all *home based businesses*.

Fences, Retaining Walls, and Similar Features

(7) The general regulations as contained in [Section 4.8](#) shall apply to all fences, retaining walls, and similar features.

Irregular Shaped Lots

(8) The general regulations as contained in [Section 4.3](#) apply to all irregular shaped *lots*.

Permitted Uses in all Zones

(9) The general regulations as contained in [Section 4.1](#) of this Bylaw include *uses* that are permitted in addition to the *uses* permitted within this zone.

Short Term Rental

(10) The use of a *dwelling unit* for *temporary* commercial tourist accommodation whether by means of a rental pool or not, is permitted anywhere within this zone.

Swimming Pools, Hot Tubs, and Saunas

(11) The general regulations as contained in [Section 4.9](#) shall not apply to all swimming pools, hot tubs, and saunas within this zone.

Temporary Buildings and Use of a Recreational Vehicle During Construction

(12) The general regulations as contained in [Section 4.7](#) apply to *temporary buildings* and residing in a *recreational vehicle* during construction.

Vehicle Storage

(13) The general regulations as contained in [Section 4.6](#) shall apply to all parking and storage of *recreational vehicles*, boats, *commercial vehicles* and equipment.

Vision Clearance at Intersections

(14) The general regulations as contained in [Section 4.4](#) apply to all *development* within this zone.

Section 1: Administration and Enforcement	Section 2: Interpretation	Section 3: Definitions	Section 4: General Regulations	Section 5: Use-Specific Regulations	Section 6: Residential (R) Zones
Section 7: Mixed Use (MU) and Commercial (C) Zones	Section 8: Industrial (I) Zones	Section 9: Environment and Rural Recreation (E) / Public Use (P) Zones	Section 10: Comprehensive Development (CD) Zones	Section 11: Off-Street Parking Regulations	Section 12: Off-Street Loading Regulations

10.2.17 CD-02 Schedule A – Resort Neighbourhood and Resort Core Areas

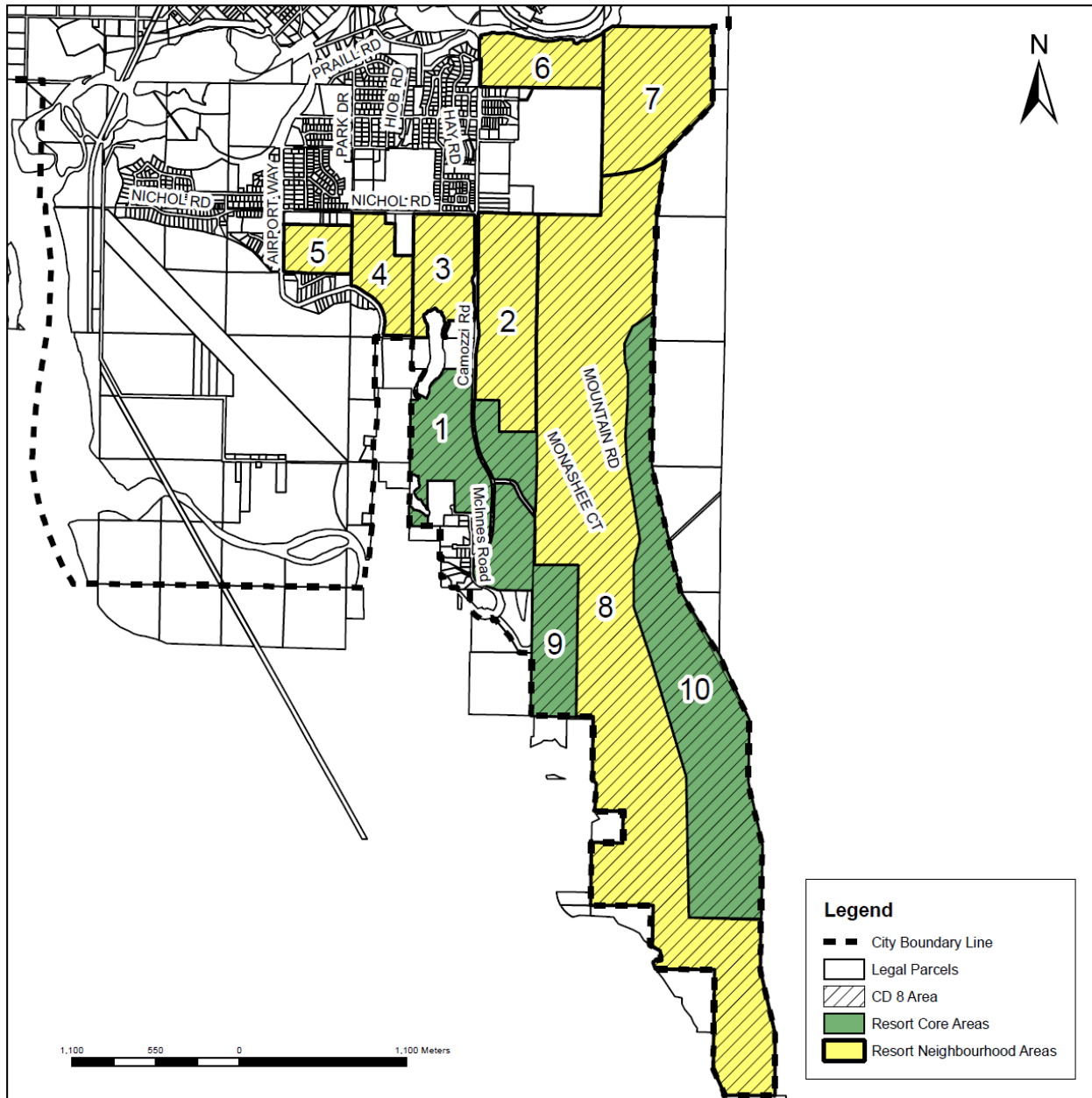

Section 1: Administration and Enforcement	Section 2: Interpretation	Section 3: Definitions	Section 4: General Regulations	Section 5: Use-Specific Regulations	Section 6: Residential (R) Zones
Section 7: Mixed Use (MU) and Commercial (C) Zones	Section 8: Industrial (I) Zones	Section 9: Environment and Rural Recreation (E) / Public Use (P) Zones	Section 10: Comprehensive Development (CD) Zones	Section 11: Off-Street Parking Regulations	Section 12: Off-Street Loading Regulations

Schedule "C"
Form P, Phased Strata Plan Declaration

**STRATA PROPERTY ACT
FORM P**

PHASED STRATA PLAN DECLARATION

(Sections 221, 222)

I, _____, authorized signatory of the applicant, Northland Properties Corporation (the "Applicant"), declare:

1. That the Applicant intends to create a strata plan by way of phased development of the following land which it owns:

PID: NO PID Lot 2, Section 23, Township 23, Range 2 West of the 6th Meridian, Kootenay District, Plan EPP_____, and an undivided 1/78 interest in Lot 1, Section 23, Township 23, Range 2 West of the 6th Meridian, Kootenay District, Plan EPP_____.

2. That the plan of development is as follows:

- (a) the development will be constructed in 4 Phases. There are no common facilities located within the development;
- (b) attached as Schedule "A" is a sketch plan showing:
- (i) all the land to be included in the phased strata plan,
 - (ii) the present parcel boundaries,
 - (iii) the approximate boundaries of each phase; and
 - (iv) the approximate location of the common facilities;
- (c) the estimated dates for the beginning of construction and completion of construction of each phase are as follows:

<u>Phase</u>	<u>Estimated Commencement of Construction Date</u>	<u>Estimated Completion of Construction Date</u>
1	Apr. 1, 2025 – June 30, 2025	Aug. 1, 2025 – Nov. 30, 2026
2	June 1, 2025 – Aug. 30, 2025	Nov. 1, 2026 – Jan. 30, 2027
3	Aug. 1, 2025 – Oct. 30, 2025	Jan. 1, 2027 – Mar. 30, 2027
4	Dec. 1, 2025 – Feb. 28, 2026	Mar. 1, 2027 – May 30, 2027

(d) The Unit Entitlement for each Strata Lot will be one. The Unit Entitlement for each Phase is as follows:

<u>Phase</u>	<u>Unit Entitlement</u>	<u>Total Unit Entitlement</u>
1	4	4
2	4	8
3	4	12
4	4	16

(e) Each Phase will consist of 1 building containing 4 strata lots.

3 The Applicant will elect to proceed with each phase on or by the following dates:

<u>Phase Number</u>	<u>Date [month, day, year]</u>
Phase 1	November 30, 2026
Phase 2	January 30, 2027
Phase 3	March 30, 2027
Phase 5	May 30, 2027

NORTHLAND PROPERTIES CORPORATION
Per:

Authorized Signatory

Date of Approval: _____

Signature of Approving Officer

* Section 222 (2) of the Act provides that approval expires after one year unless the first phase is deposited before that time.

Plan of Schedule A of Form P for Strata Subdivision of Lot 2, Sec 23, Tp 23, Rge 2, W6M, KD, Plan EPP_____

City of Revelstoke

BCGS No. 82L.100

SCALE 1:1000

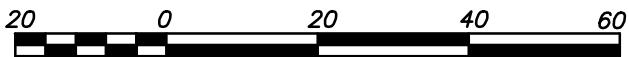

ALL DISTANCES SHOWN IN METRES AND DECIMALS THEREOF

THE INTENDED PLOT SIZE OF THIS PLAN IS 280mm IN WIDTH x
432mm IN HEIGHT (B size) WHEN PLOTTED AT A SCALE OF 1:1000

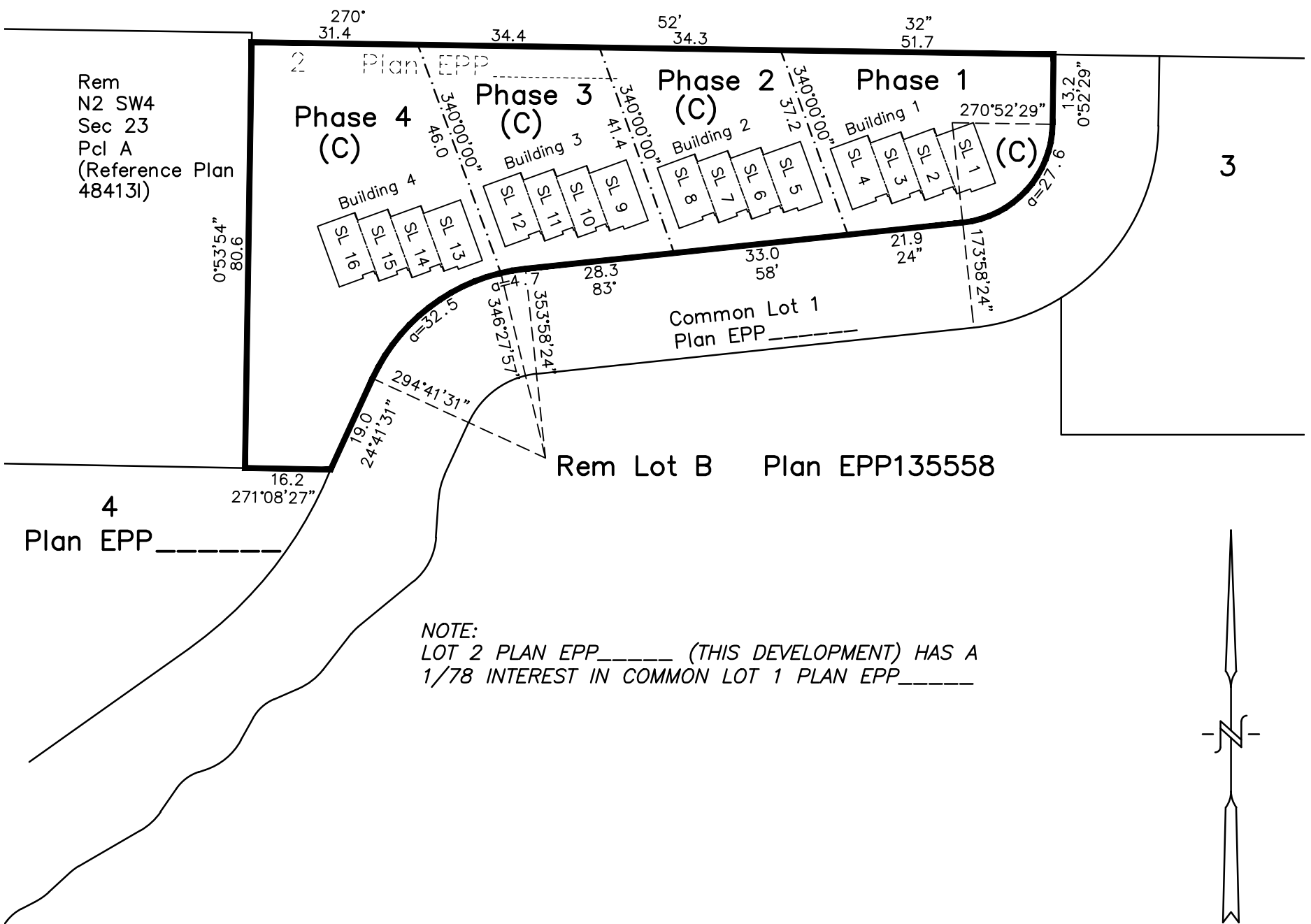

NOTE:
LOT 2 PLAN EPP_____ (THIS DEVELOPMENT) HAS A
1/78 INTEREST IN COMMON LOT 1 PLAN EPP_____

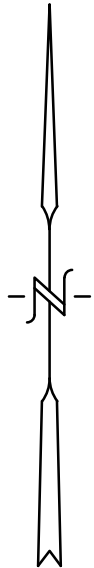

LEGEND

BEARINGS ARE GRID, AND ARE DERIVED FROM GPS OBSERVATIONS.

SL DENOTES STRATA LOT
(C) DENOTES COMMON PROPERTY

THIS PLAN LIES WITHIN THE REGIONAL DISTRICT OF
COLUMBIA SHUSWAP

CERTIFIED CORRECT THIS 28th DAY OF MARCH, 2025.

J.R. SHORTT, BCLS #770

russell shortt
land SURVEYORS
2801-32nd Street, Vernon, B.C. V1T 5L8
Phone: (250)545-0511 Email: jasons@jrshortt.ca
FILE: 30731 ds 2

Schedule "D"
Proposed Unit Entitlement

Strata Property Act

PROPOSED FORM V

SCHEDULE OF UNIT ENTITLEMENT

(Sections 245(a), 246, 264)

Re: Strata Plan EPS_____, being a strata plan of

P.I.D.: Legal Description: Lot 2, Sec 23, Tp. 23, Rge 2, W^M, Kootenay District

The unit entitlement for each residential strata lot is one of the following *[check appropriate box]*, as set out in the following table:

- (a) the habitable area of the strata lot, in square metres, rounded to the nearest whole number as determined by a British Columbia land surveyor as set out in section 246(3)(a)(i) of the *Strata Property Act*.

Certificate of British Columbia Land Surveyor

I, *Jason Russell Shortt*, a British Columbia land surveyor, certify that the following table reflects the habitable area of each residential strata lot.

Date: *March 28, 2025*

Signature

OR

- (b) a whole number that is the same for all of the residential strata lots as set out in section 246(3)(a)(ii) of the *Strata Property Act*.

OR

- (c) a number that is approved by the Superintendent of Real Estate in accordance with section 246(3)(a)(iii) of the *Strata Property Act*.

Signature of Superintendent of Real Estate

Strata Lot No.	Sheet No.	Habitable Area in m ²	Unit Entitlement	%* of Total Unit Entitlement**
1	2	197.1	1	6.25
2	2	166.3	1	6.25
3	2,	197.6	1	6.25
4	2	229.5	1	6.25
5	3	197.1	1	6.25
6	3	166.3	1	6.25
7	3	197.6	1	6.25
8	3	229.5	1	6.25
9	4	197.1	1	6.25
10	4	166.3	1	6.25
11	4	197.6	1	6.25
12	4	229.5	1	6.25
13	5	197.1	1	6.25
14	5	166.3	1	6.25
15	5	197.6	1	6.25
16	5	229.5	1	6.25
Total number of lots: 16			Total unit entitlement:16	100

* expression of percentage is for informational purposes only and has no legal effect

** not required for a phase of a phased strata plan

Date:

Signature of Owner Developer

Schedule "E"
Notice of Different Bylaws

BYLAWS

The Owners, Strata Plan EPS _____

Division 1 – Duties of Owners, Tenants, Occupants, and Visitors

1. Payment of strata fees

1.1 An owner must pay strata fees on or before the first day of the month to which the strata fees relate. Prior to the first day of the month following the meeting approving a Budget, or conveyance of a strata lot, as the case may be, an owner will provide the treasurer, or at the direction of the treasurer, the strata manager or authorized person, with post-dated cheques or other pre-authorized form of payment for the strata fees for the approved Budget period, or balance thereof, as the case may be.

1.2 The strata corporation may fine an owner \$50.00 for each occurrence of late payment of strata fees.

2. Repair and maintenance of property by owner

2.1 An owner must repair and maintain the owner's strata lot, except for repair and maintenance that is the responsibility of the strata corporation under these bylaws.

2.2 An owner who has the use of limited common property must repair and maintain it, except for repair and maintenance that is the responsibility of the strata corporation under these bylaws.

2.3 Owners are required to keep their patio/balcony free and clear of ice and snow and maintain these areas in a neat and tidy condition at all times.

3. Use of property

3.1 An owner, tenant, occupant, or visitor must not use a strata lot, the common property, or common assets in a way that:

- (a) causes a nuisance or hazard to another person;
- (b) causes unreasonable noise;
- (c) unreasonably interferes with the rights of other persons to use and enjoy the common property, common assets, or another strata lot;
- (d) is illegal; or
- (e) is contrary to a purpose for which the strata lot or common property is intended as shown expressly or by necessary implication on or by the strata plan.

3.2 An owner, tenant, occupant, or visitor must not cause damage, other than reasonable wear and tear, to the common property, common assets, or those parts of a strata lot which the strata corporation must repair and maintain under these bylaws or insure under section 149 of the Act.

3.3 An owner, tenant, occupant, or visitor must not allow on a strata lot, the limited common property, the common property, or common assets as the case may be:

- (a) the use of plumbing, water, electrical, drainage or other utility for any purpose other than for which they were constructed; or
- (b) outside burning or open fires.

3.4 An owner must keep the limited common property appurtenant to its strata lot free of debris and well maintained at all times.

3.5 Only electric barbeques and barbeques that are connected to the propane hookup located on the deck/patio of strata lots are permitted. The use of charcoal burning barbeques is prohibited.

3.6 An owner, tenant, occupant, or visitor must not drop, throw, hang, or suspend anything from windows, doors, decks, railings, or any portion of common property, including limited common property.

3.7 An owner, tenant, occupant, or visitor must not install or permit to be installed any home entertainment speaker system on or within a common wall located between adjoining strata lots; nor on any common property, including limited common property.

3.8 Each owner shall obtain liability insurance against property damage in an amount not less than \$2,000,000.00, and provide proof of such insurance as required by the council.

3.9 Anything affixed to the exterior of a strata lot, or to common property or limited common property constitutes an alteration, subject to bylaw 5.1.

3.10 Nothing may be used, stored, or placed in a strata lot or on common property, including limited common property, in such a manner that it creates a fire hazard.

3.11 An owner, tenant or occupant may not allow waste, refuse or debris to accumulate within their strata lot, nor shall any person deposit waste, refuse or debris on common property, including limited common property. Sanitary disposal of household garbage and other refuse is the responsibility of each strata lot owner, tenant, or occupant. Household garbage must be placed only in designated receptacles. Any other type of refuse must be removed from the property by the owner for proper disposal.

3.12 Signs, notices, flags, advertising, and similar items may not be placed or displayed from within a strata lot or the common property, including limited common property without the prior written approval of the strata council, except that the following signs are permitted without such approval:

- (a) Standard "For Sale" and/or "Open House" signs related to an offering of a strata lot within the Strata Plan for sale. The strata council may designate one or more areas for the display of such signs on common property from time to time by passing a rule, in which case such a sign may only be displayed in a designated area, or within the strata lot; and
- (b) Signs posted at the direction of the strata council.

3.13 An owner, tenant or occupant must not keep any pets on a strata lot other than the following:

- (a) a reasonable number of fish or other small aquarium animals;
- (b) a reasonable number of small, caged mammals;
- (c) up to 2 caged birds;
- (d) two indoor cats or two dogs or one indoor cat and one dog, but not a dog that is deemed vicious by the strata council. For purposes of this bylaw a vicious dog means the following:
 - (i) any dog that has killed or injured any person or another animal while running at large;
 - (ii) any dog that aggressively harasses or pursues another person or animal while running at large; or
 - (iii) any dog primarily owned or in part for the purpose of dog fighting or is trained for dog fighting.

3.14 An owner, tenant, occupant, or visitor must ensure that all animals are leashed or otherwise secured when on the common property or on land that is a common asset.

3.15 An owner, tenant, occupant, or visitor must pick up and properly dispose of all droppings, litter, and other matter of his/her pet. Each incidence of non-compliance, regardless of the time of day, day, or month, will be considered a new contravention of this bylaw and subject to fines in accordance with bylaw 23.

3.16 An owner, tenant, occupant, or visitor must not allow his/her pet to cause a nuisance or disturbance to any other owner, tenant, occupant, or visitor or allow such pet to cause damage to any property or person on or in the strata plan.

3.17 The strata council may give written notice that a pet is causing an annoyance to others and require that the annoyance cease forthwith. If the annoyance does not cease, the strata council may at any time require that the pet be removed forthwith.

4. Inform strata corporation

4.1 Within 2 weeks of becoming an owner, an owner must inform the strata corporation of the owner's name, strata lot number and mailing address outside the strata plan, if any, and an emergency contact number.

4.2 On request by the strata corporation, a tenant must inform the strata corporation of his or her name, unit number and emergency contact number.

4.3 Pursuant to Section 146 of the Strata Property Act, the owner of a strata lot is required to provide the strata corporation a copy of the Form K within 2 weeks of renting the strata lot.

5. Obtain approval before altering a strata lot

5.1 An owner must obtain the written approval of the strata corporation before making an alteration to a strata lot that involves any of the following:

- (a) the structure of a building;
- (b) the exterior of a building;
- (c) chimneys, stairs, balconies, or other things attached to the exterior of the building;
- (d) doors or windows on the exterior of a building, or that front on the common property;
- (e) fences, railings, or similar structures that enclose a patio, balcony, or yard;
- (f) common property located within the boundaries of a strata lot;
- (g) those parts of the strata lot which the strata corporation must insure under section 149 of the Act.

5.2 The strata corporation must not unreasonably withhold its approval under subsection 5.1, but may require as a condition of its approval that the owner agree, in writing, to take responsibility for any expenses relating to the alteration.

6. Obtain approval before altering common property

6.1 An owner must obtain the written approval of the strata corporation before making an alteration to common property, including limited common property, or common assets.

6.2 The strata corporation may require as a condition of its approval that the owner agree, in writing, to take responsibility for any expenses relating to the alteration.

7. Permit entry to strata lot

7.1 An owner, tenant, occupant, or visitor must allow a person authorized by the strata corporation to enter the strata lot:

- (a) in an emergency, without notice, to ensure safety or prevent significant loss or damage, and
- (b) at a reasonable time, on 48 hours' written notice,
 - (i) to inspect, repair or maintain common property, common assets and any portions of a strata lot that are the responsibility of the strata corporation to repair and maintain under these bylaws or insure under section 149 of the Act, or
 - (ii) to ensure compliance with the Act and the Bylaws.

7.2 The notice referred to in subsection 7.1(b) must include the date and approximate time of entry, and the reason for entry.

Division 2 – Powers and Duties of Strata Corporation

8. Repair and maintenance of property by strata corporation

8.1 The strata corporation must repair and maintain all of the following:

- (a) common assets of the strata corporation;
- (b) common property that has not been designated as limited common property;
- (c) limited common property, but the duty to repair and maintain it is restricted to:
 - (i) repair and maintenance that in the ordinary course of events occurs less often than once a year, and
 - (ii) the following, no matter how often the repair or maintenance ordinarily occurs:
 - (A) the structure of a building;
 - (B) the exterior of a building;
 - (C) chimneys, stairs, balconies, and other things attached to the exterior of a building;
 - (D) doors, windows, or skylights on the exterior of a building or that front on the common property;
 - (E) fences, railings, and similar structures that enclose patios, balconies, and yards;
 - (F) landscaping along the driveways designated as limited common property;
- (d) a strata lot in a strata plan that is not a bare land strata plan, but the duty to repair and maintain it is restricted to:
 - (i) the structure of a building;
 - (ii) the exterior of a building;
 - (iii) chimneys, stairs, balconies, and other things attached to the exterior of a building;
 - (A) doors and windows on the exterior of a building or that front on the common property, and
 - (B) fences, railings, and similar structures that enclose patios, balconies, and yards.

Division 3 -- Council**9. Council size**

9.1 Subject to subsection 9.2, the council must have at least 3 and not more than 7 members.

9.2 If the strata plan has fewer than 4 strata lots or the strata corporation has fewer than 4 owners all the owners are on the council.

9.3 No owner shall be entitled to sit on council if the strata corporation is entitled to file a lien against that owner's strata lot. A person who is no longer eligible for council under this section is conclusively deemed to have resigned pursuant to section 12.1.

10. Council members' terms

10.1 The term of office of a council member ends at the end of the annual general meeting at which a replacement is elected.

10.2 A person whose term as council member is ending is eligible for reelection.

11. Removing council member

11.1 Unless all owners are on the council, the strata corporation may, by a resolution passed by a majority vote at an annual or special meeting, remove one or more council members.

11.2 After removing a council member, the strata corporation must hold an election at the same annual or special general meeting to replace the council member for the remainder of the term.

12. Replacing council member

12.1 If a council member resigns or is unwilling or unable to act for a period of 2 or more months, the remaining members of the council may appoint a replacement council member for the term.

12.2 A replacement council member may be appointed from any person eligible to sit on the council.

12.3 The council may appoint a council member under this section even if the absence of the member being replaced leaves the council without a quorum.

12.4 If all the members of the council resign or are unwilling or unable to act for a period of 2 or more months, persons holding at least 25% of the strata corporation's votes may hold a special general meeting to elect a new council by complying with the provisions of the Act, the regulations and the bylaws respecting the calling and holding of meetings.

13. Officers

13.1 At the first meeting of the council held after each annual general meeting of the strata corporation, the council must elect, from among its members, a president, a vice president, a secretary, and a treasurer.

13.2 A person may hold more than one office at a time, other than the offices of president and vice-president.

13.3 The vice president has the powers and duties of the president:

- (a) while the president is absent or is unwilling or unable to act, or
- (b) for the remainder of the president's term if the president ceases to hold office.

13.4 If an officer other than the president is unwilling or unable to act for a period of 2 or more months, the council members may appoint a replacement officer from among themselves for the remainder of the term.

14. Calling council meetings

14.1 Any council member may call a council meeting by giving the other council members at least one week's notice of the meeting, specifying the reason for calling the meeting.

14.2 The notice does not have to be in writing.

14.3 A council meeting may be held on less than one week's notice if:

- (a) all council members consent in advance of the meeting, or
- (b) the meeting is required to deal with an emergency situation, and all council members either:
 - (i) consent in advance of the meeting, or
 - (ii) are unavailable to provide consent after reasonable attempts to contact them.

14.4 The council must inform owners about a council meeting as soon as possible after the meeting has been called.

15. Repealed

16. Quorum of council

16.1 A quorum of the council is:

- (a) 1, if the council consists of one member,
- (b) 2, if the council consists of 2, 3, or 4 members,
- (c) 3, if the council consists of 5 or 6 members, and
- (d) 4, if the council consists of 7 members.

16.2 Council members must be present in person or via electronic means at the council meeting to be counted in establishing quorum.

17. Council Meetings

17.1 At the option of the council, council meetings may be held by electronic means, so long as all council members and other participants can communicate with each other.

17.2 If a council meeting is held by electronic means, council members are deemed to be present in person.

17.3 Owners may attend council meetings as observers.

17.4 Despite subsection 17.3, no observers may attend those portions of council meetings that deal with any of the following:

- (a) bylaw contravention hearings under section 135 of the Act; and
- (b) any other matters if the presence of observers would, in the council's opinion, unreasonably interfere with an individual's privacy.

18. Voting at council meetings

18.1 At council meetings, decisions must be made by a majority of council members present in person at the meeting.

18.2 Unless there are only 2 strata lots in the strata plan, if there is a tie vote at a council meeting, the president may break the tie by casting a second, deciding vote.

18.3 The results of all votes at a council meeting must be recorded in the council meeting minutes.

19. Council to inform owners of minutes

19.1 The council must inform owners of the minutes of all council meetings within 2 weeks of the meeting, whether or not the minutes have been approved.

20. Delegation of council's powers and duties

20.1 Subject to subsections 20.2 to 20.4, the council may delegate some or all of its powers and duties to one or more council members or persons who are not members of the council, and may revoke the delegation.

20.2 The council may delegate its spending powers or duties, but only by a resolution that:

- (a) delegates the authority to make an expenditure of a specific amount for a specific purpose, or
- (b) delegates the general authority to make expenditures in accordance with subsection 20.3.

20.3 A delegation of a general authority to make expenditures must:

- (a) set a maximum amount that may be spent, and
- (b) indicate the purposes for which, or the conditions under which, the money may be spent.

20.4 The council may not delegate its powers to determine, based on the facts of a particular case:

- (a) whether a person has contravened a bylaw or rule,
- (b) whether a person should be fined, and the amount of the fine, or
- (c) whether a person should be denied access to a recreational facility.

21. Spending Restrictions

21.1 A person may not spend the strata corporation's money unless the person has been delegated the power to do so in accordance with these bylaws.

21.2 Despite subsection 21.1, a council member may spend the strata corporation's money to repair or replace common property or common assets if the repair or replacement is immediately required to ensure safety or prevent significant loss or damage.

22. Limitation on liability of council member

22.1 A council member who acts honestly and in good faith is not personally liable because of anything done or omitted in the exercise or intended exercise of any power or the performance or intended performance of any duty of the council.

22.2 Subsection 22.1 does not affect a council member's liability, as an owner, for a judgment against the strata corporation.

Division 4 – Enforcement of Bylaws and Rules

23. Maximum Fine

23.1 The strata corporation may fine an owner or an owner on behalf of that owner's tenant's contravention, a maximum of:

- (a) \$200.00 for each contravention of a bylaw, and
- (b) \$50.00 for each contravention of a rule.

23.2 The strata corporation may charge interest on late fines of up to 10% compounded annually.

24. Continuing contravention

24.1 If an activity or lack of activity that constitutes a contravention of a bylaw or rule continues, without interruption, for longer than 7 days, a fine may be imposed every 7 days.

Division 5 – Annual and Special General Meetings

25. Person to chair meeting

25.1 Annual and special general meetings must be chaired by the president of the council.

25.2 If the president of the council is unwilling or unable to act, the meeting must be chaired by the vice president of the council.

25.3 If neither the president nor the vice president of the council chairs the meeting, a chair must be elected by the eligible voters present in person or by proxy from among those persons who are present at the meeting.

26. Participation by other than eligible voters

26.1 Tenants and occupants may attend annual and special general meetings, whether or not they are eligible to vote.

26.2 Persons who are not eligible to vote, including tenants and occupants, may participate in the discussion at the meeting, but only if permitted to do so by the chair of the meeting.

26.3 Persons who are not eligible to vote, including tenants and occupants, must leave the meeting if requested to do so by a resolution passed by a majority vote at the meeting.

27. Voting

27.1 At an annual or special general meeting, voting cards must be issued to eligible voters.

27.2 No owner shall be an eligible voter if that owner is in arrears of strata fees, fine or penalties imposed by the strata corporation.

27.3 At an annual or special general meeting a vote is decided on a show of voting cards unless an eligible voter requests a precise count.

27.4 If a precise count is requested, the chair must decide whether it will be show of voting cards or by roll call, secret ballot, or some other method.

27.5 The outcome of each vote, including the number of votes for and against the resolution if a precise count is requested, must be announced by the chair, and recorded in the minutes of the meeting.

27.6 If there is a tie vote at an annual or special general meeting, the president, or, if the president is absent or unable or unwilling to vote, the vice president, may break the tie by casting a second, deciding vote.

27.7 If there are only 2 strata lots in the strata plan, subsection 27.5 does not apply.

27.8 Despite anything in this section, an election of council or any other vote must be held by secret ballot, if the secret ballot is requested by an eligible voter.

28. Order of business

28.1 The order of business at annual and special general meetings is as follows:

- (a) certify proxies and corporate representatives and issue voting cards;
- (b) determine that there is a quorum;

- (c) elect a person to chair the meeting, if necessary;
- (d) present to the meeting proof of notice of meeting or waiver of notice;
- (e) approve the agenda;
- (f) approve minutes from the last annual or special general meeting;
- (g) deal with unfinished business;
- (h) receive reports of council activities and decisions since the previous annual general meeting, including reports of committees, if the meeting is an annual general meeting;
- (i) ratify any new rules made by the strata corporation under section 125 of the Act;
- (j) report on insurance coverage in accordance with section 154 of the Act, if the meeting is an annual general meeting;
- (k) approve the budget for the coming year in accordance with section 103 of the Act, if the meeting is an annual general meeting;
- (l) deal with new business, including any matters about which notice has been given under section 45 of the Act;
- (m) elect a council if the meeting is an annual general meeting;
- (n) terminate the meeting.

Division 6 – Voluntary Dispute Resolution

29. Voluntary dispute resolution

29.1 A dispute among owners, tenants, the strata corporation, or any combination of them may be referred to a dispute resolution committee by a party to the dispute if:

- (a) all the parties to the dispute consent, and
- (b) the dispute involves the Act, the regulations, the bylaws, or the rules.

29.2 A dispute resolution committee consists of:

- (a) one owner or tenant of the strata corporation nominated by each of the disputing parties and one owner or tenant chosen to chair the committee by the persons nominated by the disputing parties, or
- (b) any number of persons consented to, or chosen by a method that is consented to, by all the disputing parties.

29.3 The dispute resolution committee must attempt to help the disputing parties to voluntarily end the dispute.

Division 7 – Guidelines for use of Common Property and Common Facilities

30. Use of Common Property

30.1 Subject to and including the prohibitions contained in section 35 and any other bylaw relating to the common property contained in these bylaws, the following provisions apply and govern the use of the common property:

- (a) An owner or tenant is solely responsible to supervise his or her visitors, guests, and minor children. Owners are solely responsible to remedy or cause the remedy, of any breach of any bylaw, rule, or regulation and for any damage caused by such owner or such owner's tenant, including their guests, visitors, invitees, or children.
- (b) An owner, tenant, occupier, or visitor must tidy and clean up after his/her use of the common property so as to leave such area in the same or better condition as it was prior to such use.
- (c) An owner, tenant, occupier, or visitor must not complete any maintenance to vehicles including oil changes on any Common Property, including limited common property.
- (d) An owner, tenant, occupier, or visitor must not place any hot tubs, or structures surrounding the hot tubs, on any common property, including limited common property, without the prior written approval of the board, acting reasonably; PROVIDED HOWEVER, that no hot tubs shall exceed 78" x 78" in size. The use of hot tubs shall be governed by the rules enacted by the board from time to time. Breach of the rules shall constitute a breach of these Bylaws, and in addition shall be grounds for the board to reasonably revoke its approval for the construction of a hot tub, and the owner may accordingly be required to remove the hot tub.

Division 8 – General Prohibitions

31. Conducting business from a residential strata lot

31.1 No owner, tenant, occupier, or visitor may carry on a trade or business upon a residential strata lot unless permitted under the zoning bylaws of the City of Revelstoke applicable to the strata lot from time to time. An owner, tenant, occupier, or visitor of a residential strata lot must notify the strata council of his/her intention to carry on a trade or business and will, at the request of the strata council, place additional insurance at his/her sole cost and indemnify the strata corporation from any loss or claims arising from the carrying on of a business from the residential strata lot. The strata council may prohibit the operation of a home based business, if in its opinion, acting reasonably, such business causes a nuisance to other owners.

32. General

32.1 An owner, tenant, occupier, or visitor shall not:

- (a) permit, store, erect, or hang over or cause to be erected or to remain outside any window, door or balcony or any other part of a strata lot or on the common property, clothes lines, garbage disposal equipment, barriers, partitions, awnings, shades, or screens;
- (b) use patios or balconies for general storage purposes or allow such areas to become untidy or unsightly;
- (c) hang, or permit to be hung, on any window, flags, sheets, or other like materials to be used as window coverings. For greater certainty, only blinds or curtains/drapes shall be used as window coverings.
- (d) place or permit the placement of propane tanks or charcoal burning barbeques anywhere within a strata lot or the common property, including limited common property;
- (e) affix or permit to be affixed any radio, TV or satellite, dish, antenna to the exterior of the strata lot, common property, or limited common property;

- (f) do anything or permit anything to be done in his/her strata lot or on the common property or fail to do any act or thing which will or would tend to increase the risk of fire or the rate of fire insurance premiums with respect thereto or which would render invalid any insurance maintained by the strata corporation;
- (g) permit any member of his/her household, guests, or visitors to trespass on the part of the strata plan which another owner is entitled to exclusive use;
- (h) use or permit the use of his/her residential strata lot other than as a residential dwelling or short term rental. Secondary suites are not permitted, unless included as part of a strata lot at the time of original construction;
- (i) use a driveway for any purpose other than ingress and egress or for the parking of an insured motor vehicle which does not exceed the dimensions of a private automobile, van, or pickup;
- (j) park motorhomes, campers, trailers, recreational vehicles of any type, boats, equipment, unlicensed vehicles or containers on the common property or limited common property;
- (k) wash vehicles or perform maintenance on any vehicle in such a manner that will cause nuisance or annoyance to other owners or occupiers;
- (l) obstruct or use the sidewalks, walkways, passages, driveways, or the common property for any purpose other than that for which each was designed;
- (m) hang laundry or washing in such a way as to be visible from the outside of a strata lot;
- (n) keep or accumulate or permit to be kept or accumulated any debris, refuse, or waste material upon the strata lot or the common property which may be visible to others;
- (o) use any instrument or device within a strata lot or upon the common property which in the opinion of the strata council causes disturbance or interferes with the comfort of other owners or occupiers;
- (p) affix or install or otherwise place any sign, placard, or notice on or in the strata plan without the prior written consent of the council. Council will determine an appropriate location for the display of 'For Sale' signs and an owner must obtain the consent of the council to place any such sign or notice; and
- (q) install or erect, or permit to be installed or erected, any fencing enclosing common property or limited common property.

Division 9 – Security and Insurance

33. Insurance and Security

33.1 An owner is deemed to be responsible for any loss or damage caused to the common property, limited common property, common assets or to any strata lot, personal injury, death or any other loss or damage; where the original cause of any such loss or damage originated within the owner's strata lot or an occupant's vehicle and to the extent that the loss or damage is not fully paid from the proceeds of an insurance policy.

33.2 An owner is also deemed to be responsible for any loss or damage to the common property, limited common property, common assets or to any strata lot, personal injury, death or any other loss or damage; where the cause of any such loss or damage is the result of an act, omission, negligence or carelessness of the owner, and/or owner's tenants, occupants, employees, agents, visitors or invitees, and to the extent that the loss or damage is not fully paid from the proceeds of an insurance policy.

33.3 If any loss or damage deemed to be the responsibility of an owner under Section 33.1 and/or Section 33.2 of this bylaw results in a claim against any insurance policy held by the Strata Corporation; that owner is strictly liable to reimburse the Strata Corporation for the full amount of any insurance deductible, any portion of insurance coverage declined and/or any amount by which the loss or damage exceeds the insurance coverage. That owner shall indemnify and save harmless the Strata Corporation for these amounts.

33.4 If any loss or damage deemed to be the responsibility of an owner under Section 33.1 and/or Section 33.2 of this bylaw does not exceed the insurance deductible for an insurance policy held by the Strata Corporation, that owner is strictly liable and shall fully indemnify and save harmless the Strata Corporation for any resulting expense for maintenance, repair or replacement rendered necessary, which it is the Strata Corporation's responsibility to perform.

33.5 If an owner is deemed or determined to be responsible for any insurance deductible, any loss or damage to the common property, limited common property, common assets or to any strata lot, personal injury, death or any other loss or damage whatsoever pursuant to these bylaws, the owner must fully indemnify the Strata Corporation for all reasonable legal expenses incurred in relation to defending any related claim against the Strata Corporation, and/or prosecuting any claim made against the owner, such indemnity to be on a solicitor and own client basis, including legal fees, disbursements, expenses, taxes, filing and/or court fees, all on a full indemnity basis.

33.6 Owners are responsible to ensure that their strata lot interior is maintained at a minimum temperature of 15 degrees centigrade, year round. Any water pipe leak, burst, damage resulting from condensation or any other loss or damage whatsoever which the strata council reasonably determines resulted from or is contributed to by an owner's failure to comply with this bylaw shall constitute loss or damage which is deemed to be the responsibility of that owner pursuant to these bylaws, whether the loss or damage occurs within that owners' strata lot, within adjacent common property, or within an adjacent strata lot.

33.7 The Strata Corporation may arrange emergency damage mitigation and restoration where damage has been done within a strata lot, and the costs of gaining access to the strata lot, and preventing further damage may be paid as a common expense of the Strata Corporation until such a time as the strata council is able to determine whether the expense will be:

- (a) Covered by strata insurance;
- (b) Treated as a common expense of the Strata Corporation;
- (c) Charged back to the owner of the affected strata lot; or
- (d) Charged back to the strata lot where the source of the damage originated.

The final determination with respect to the assignment of the expense shall be made by the strata council subject to the bylaws relating to responsibility for repair and maintenance as well as insurance and indemnity.

Division 10 – Marketing Activities by Owner Developer

34. Display lot

34.1 An owner developer who has an unsold strata lot may carry on sales functions that relate to its sale, including the posting of signs.

34.2 An owner developer may use the common property including any common facilities for any purpose relating to sales functions of the strata lots for as long as the owner developer, or subsidiary thereof, retains a registered interest in any strata lot in the strata plan.

34.3 An owner developer may use a strata lot, that the owner developer owns or rents, as a display lot for the sale of other strata lots in the strata plan.

Division 11 – Miscellaneous

35. Smoking Restriction

35.1 Due to the irritation and known health risks of exposure to second-hand tobacco smoke, increased risk of fire and increased maintenance and cleaning costs, all forms of smoking are prohibited on the common property, including but not limited to:

- (a) on any part of the property that is a common element or exclusive use common element, including parkades, balconies, patios, and terraces;
- (b) within 7.5m of any building entries, outdoor air intakes, and operable windows; and
- (c) hallways, elevators, storage lockers, electrical rooms, and mechanical rooms.

35.2 For the purposes of bylaw 35.1, the term “smoking” shall include the inhaling, exhaling, burning, or carrying of lighted tobacco, electronic or e-cigarettes, and marijuana products.

35.3 Bylaw 35.1 applies to all persons, including but not limited to owners, tenants, invitees, business invitees, occupants, and visitors. An owner or tenant is responsible for any and all parties who are admitted on the premises by the owner or tenant if such parties are in violation of the no-smoking bylaw, and such owner or tenant may be fined under this section.

35.4 For the purposes of bylaw 35.3, the term “business invitee” shall include but is not limited to any contractor, tradesperson, agent, household worker, or other person hired by an owner, a tenant or resident to provide a service or product.

35.5 Notice of the no-smoking bylaw shall be contained within all status certificates provided by the condominium corporation. Tenant lease documents must also contain this notice.

35.6 In the event there is suspicion of smoking in the aforementioned areas, residents may fill out a complaint form and submit it to the board for further investigation. The strata corporation may fine an owner or tenant if there is reasonable proof of a violation.

35.7 The strata corporation may fine owner or tenant for each contravention of the bylaw set out in this section to a maximum of \$200.00.

35.8 Any amendment to bylaws 35.1, 35.2 and 35.3 shall require the unanimous consent of the owners of all strata lots.

Schedule "F"
Budget

**PROPOSED ANNUAL OPERATING BUDGET
REVELSTOKE RESORT
PREPARED NOVEMBER 2024**

**PROPOSED
BUDGET**

INCOME

Strata Fees	22,174.13
Interest Income	0.00
Other Income	2,217.41
TOTAL INCOME	24,391.54

GENERAL EXPENSES

Insurance	5,000.00
Insurance Appraisal	600.00
Management	2,080.00
Professional Fees	500.00
Administration & Portal	750.00
Tax Returns	750.00
Bank Charges	156.00
TOTAL GENERAL EXPENSES	9,836.00

BUILDING EXPENSES

Repairs and Maintenance	1,500.00
Landscaping	1,500.00
Fire Inspection / Backflow Testing	500.00
Common Lot Expense	839.13
Snow Removal	1,500.00

TOTAL BUILDING EXPENSES **5,839.13**

UTILITIES

Electricity	1,800.00
Garbage & Recycle	4,200.00
Water & Sewer	499.00
TOTAL UTILITIES	6,499.00

STRATA RESERVE FUNDS

Contingency Reserve Fund	2,217.41
--------------------------	----------

DEVELOPER RESERVE FUNDS

Developer Contribution to CRF	2,217.41
-------------------------------	----------

*One-time developer contribution to CRF, 10% of all phases budget

TOTAL RESERVE FUNDS **4,434.83**

TOTAL EXPENSES & RESERVES **24,391.54**

SURPLUS / (DEFICIT) **0.00**

**REVELSTOKE RESORT
PROPOSED STRATA FEE SCHEDULE
PHASE 1**

Unit No.	Strata Lot	Unit Entitlement	Operating Fund Contributions	Contingency Reserve Fund Contributions	Total Annual Strata Fees	Approved Monthly Strata Fees
	1	1	\$ 5,543.53	\$ 554.35	\$6,097.89	\$508.16
	2	1	\$ 5,543.53	\$ 554.35	\$6,097.89	\$508.16
	3	1	\$ 5,543.53	\$ 554.35	\$6,097.89	\$508.16
	4	1	\$ 5,543.53	\$ 554.35	\$6,097.89	\$508.16
NA	Developer CRF Contribution			\$ 2,217.41		
TOTALS		4	\$ 22,174.13	\$ 4,434.83	\$ 24,391.54	\$ 2,032.63

**PROPOSED ANNUAL OPERATING BUDGET
REVELSTOKE RESORT
PREPARED NOVEMBER 2024**

**PROPOSED
BUDGET**

INCOME

Strata Fees	35,554.13
Interest Income	0.00
Other Income	3,555.41
TOTAL INCOME	39,109.54

GENERAL EXPENSES

Insurance	10,000.00
Insurance Appraisal	600.00
Management	4,160.00
Professional Fees	500.00
Administration & Portal	750.00
Tax Returns	750.00
Bank Charges	156.00
TOTAL GENERAL EXPENSES	16,916.00

BUILDING EXPENSES

Repairs and Maintenance	3,000.00
Landscaping	3,000.00
Fire Inspection / Backflow Testing	500.00
Common Lot Expense	839.13
Snow Removal	3,000.00

TOTAL BUILDING EXPENSES **10,339.13**

UTILITIES

Electricity	3,600.00
Garbage & Recycle	4,200.00
Water & Sewer	499.00
TOTAL UTILITIES	8,299.00

STRATA RESERVE FUNDS

Contingency Reserve Fund	3,555.41
--------------------------	----------

TOTAL RESERVE FUNDS **3,555.41**

TOTAL EXPENSES & RESERVES **39,109.54**

SURPLUS / (DEFICIT) **0.00**

**REVELSTOKE RESORT
PROPOSED STRATA FEE SCHEDULE
PHASE 1**

Unit No.	Strata Lot	Unit Entitlement	Operating Fund Contributions	Contingency Reserve Fund Contributions	Total Annual Strata Fees	Approved Monthly Strata Fees
	1	1	\$ 4,444.27	\$ 444.43	\$4,888.69	\$407.39
	2	1	\$ 4,444.27	\$ 444.43	\$4,888.69	\$407.39
	3	1	\$ 4,444.27	\$ 444.43	\$4,888.69	\$407.39
	4	1	\$ 4,444.27	\$ 444.43	\$4,888.69	\$407.39
	5	1	\$ 4,444.27	\$ 444.43	\$4,888.69	\$407.39
	6	1	\$ 4,444.27	\$ 444.43	\$4,888.69	\$407.39
	7	1	\$ 4,444.27	\$ 444.43	\$4,888.69	\$407.39
	8	1	\$ 4,444.27	\$ 444.43	\$4,888.69	\$407.39
TOTALS		8	\$ 35,554.13	\$ 3,555.41	\$39,109.54	\$3,259.13

**PROPOSED ANNUAL OPERATING BUDGET
REVELSTOKE RESORT
PREPARED NOVEMBER 2024**

**PROPOSED
BUDGET**

INCOME

Strata Fees	53,134.13
Interest Income	0.00
Other Income	5,313.41
TOTAL INCOME	58,447.54

GENERAL EXPENSES

Insurance	15,000.00
Insurance Appraisal	600.00
Management	6,240.00
Professional Fees	500.00
Administration & Portal	750.00
Tax Returns	750.00
Bank Charges	156.00
TOTAL GENERAL EXPENSES	23,996.00

BUILDING EXPENSES

Repairs and Maintenance	4,500.00
Landscaping	4,500.00
Fire Inspection / Backflow Testing	500.00
Common Lot Expense	839.13
Snow Removal	4,500.00

TOTAL BUILDING EXPENSES **14,839.13**

UTILITIES

Electricity	5,400.00
Garbage & Recycle	8,400.00
Water & Sewer	499.00
TOTAL UTILITIES	14,299.00

STRATA RESERVE FUNDS

Contingency Reserve Fund	5,313.41
--------------------------	----------

TOTAL RESERVE FUNDS **5,313.41**

TOTAL EXPENSES & RESERVES **58,447.54**

SURPLUS / (DEFICIT) **0.00**

**REVELSTOKE RESORT
PROPOSED STRATA FEE SCHEDULE
PHASE 1**

Unit No.	Strata Lot	Unit Entitlement	Operating Fund Contributions	Contingency Reserve Fund Contributions	Total Annual Strata Fees	Approved Monthly Strata Fees
	1	1	\$ 4,427.84	\$ 442.78	\$4,870.63	\$405.89
	2	1	\$ 4,427.84	\$ 442.78	\$4,870.63	\$405.89
	3	1	\$ 4,427.84	\$ 442.78	\$4,870.63	\$405.89
	4	1	\$ 4,427.84	\$ 442.78	\$4,870.63	\$405.89
	5	1	\$ 4,427.84	\$ 442.78	\$4,870.63	\$405.89
	6	1	\$ 4,427.84	\$ 442.78	\$4,870.63	\$405.89
	7	1	\$ 4,427.84	\$ 442.78	\$4,870.63	\$405.89
	8	1	\$ 4,427.84	\$ 442.78	\$4,870.63	\$405.89
	9	1	\$ 4,427.84	\$ 442.78	\$4,870.63	\$405.89
	10	1	\$ 4,427.84	\$ 442.78	\$4,870.63	\$405.89
	11	1	\$ 4,427.84	\$ 442.78	\$4,870.63	\$405.89
	12	1	\$ 4,427.84	\$ 442.78	\$4,870.63	\$405.89
TOTALS		12	\$ 53,134.13	\$ 5,313.41	\$58,447.54	\$4,870.63

**PROPOSED ANNUAL OPERATING BUDGET
REVELSTOKE RESORT
PREPARED NOVEMBER 2024**

**PROPOSED
BUDGET**

INCOME

Strata Fees	66,514.13
Interest Income	0.00
Other Income	6,651.41
TOTAL INCOME	73,165.54

GENERAL EXPENSES

Insurance	20,000.00
Insurance Appraisal	600.00
Management	8,320.00
Professional Fees	500.00
Administration & Portal	750.00
Tax Returns	750.00
Bank Charges	156.00
TOTAL GENERAL EXPENSES	31,076.00

BUILDING EXPENSES

Repairs and Maintenance	6,000.00
Landscaping	6,000.00
Fire Inspection / Backflow Testing	500.00
Common Lot Expense	839.13
Snow Removal	6,000.00

TOTAL BUILDING EXPENSES 19,339.13

UTILITIES

Electricity	7,200.00
Garbage & Recycle	8,400.00
Water & Sewer	499.00
TOTAL UTILITIES	16,099.00

STRATA RESERVE FUNDS

Contingency Reserve Fund	6,651.41
--------------------------	----------

TOTAL RESERVE FUNDS 6,651.41

TOTAL EXPENSES & RESERVES 73,165.54

SURPLUS / (DEFICIT) 0.00

**REVELSTOKE RESORT
PROPOSED STRATA FEE SCHEDULE
PHASE 1**

Unit No.	Strata Lot	Unit Entitlement	Operating Fund Contributions	Contingency Reserve Fund Contributions	Total Annual Strata Fees	Approved Monthly Strata Fees
	1	1	\$ 4,157.13	\$ 415.71	\$4,572.85	\$381.07
	2	1	\$ 4,157.13	\$ 415.71	\$4,572.85	\$381.07
	3	1	\$ 4,157.13	\$ 415.71	\$4,572.85	\$381.07
	4	1	\$ 4,157.13	\$ 415.71	\$4,572.85	\$381.07
	5	1	\$ 4,157.13	\$ 415.71	\$4,572.85	\$381.07
	6	1	\$ 4,157.13	\$ 415.71	\$4,572.85	\$381.07
	7	1	\$ 4,157.13	\$ 415.71	\$4,572.85	\$381.07
	8	1	\$ 4,157.13	\$ 415.71	\$4,572.85	\$381.07
	9	1	\$ 4,157.13	\$ 415.71	\$4,572.85	\$381.07
	10	1	\$ 4,157.13	\$ 415.71	\$4,572.85	\$381.07
	11	1	\$ 4,157.13	\$ 415.71	\$4,572.85	\$381.07
	12	1	\$ 4,157.13	\$ 415.71	\$4,572.85	\$381.07
	13	1	\$ 4,157.13	\$ 415.71	\$4,572.85	\$381.07
	14	1	\$ 4,157.13	\$ 415.71	\$4,572.85	\$381.07
	15	1	\$ 4,157.13	\$ 415.71	\$4,572.85	\$381.07
	16	1	\$ 4,157.13	\$ 415.71	\$4,572.85	\$381.07
TOTALS		16	\$ 66,514.13	\$ 6,651.41	\$73,165.54	\$6,097.13

Schedule "G"
Rent Charge/219 Covenant

TERMS OF INSTRUMENT – PART 2

RENT CHARGE AGREEMENT – AMENITIES AND SERVICES
SECTION 219 COVENANT

BETWEEN:

NORTHLAND PROPERTIES CORPORATION, a company continued under the laws of the Province of British Columbia and having an office located at 2950 Camozzi Road, Revelstoke, BC V0E 2S0

(hereinafter collectively called the “Grantor”)

AND:

REVELSTOKE MOUNTAIN RESORT INC., a company incorporated under the laws of the Province of British Columbia and having an office located at 2950 Camozzi Road, Revelstoke, BC V0E 2S0

(hereinafter called the “Grantee”)

WHEREAS:

- A. The Grantor is the present registered owner of the Lands (as hereinafter defined) located in the City of Revelstoke and more particularly described in Item 2 of Part 1, of the Land Title Act Form C to which this Agreement is attached and which forms part of this Agreement;
- B. The Grantee is a company related to the developer of the Resort (as hereinafter defined) and may provide to the Grantor and other owners and occupiers of the land at the Resort the Amenities and Services (as hereinafter defined) on the condition that the Grantor pay to the Grantee an annual rent charge (as hereinafter defined) calculated in accordance with this Agreement.
- C. Section 219 of the Land Title Act, R.S.B.C., 1996 c. 250, provides that a covenant, in favour of the Grantee, whether of a negative or positive nature, in respect of the use of the Lands (as hereinafter defined) or that the Lands are or are not to be built on, may be registered as a charge against the title to the Lands and is enforceable against the Grantor and its successors in title even if the covenant is not annexed to land owned by the Grantee;
- D. The Grantee has been designated under section 219(3)(c) of the *Land Title Act*, evidence of which designation has been filed in the Kamloops / Nelson Land Title Office under instrument number LB090393;
- E. The Grantor has agreed to grant to the Grantee a charge against the Lands to secure payment of the Rent Charge herein created and to enter into this Covenant with the Grantee in accordance with section 219 of the *Land Title Act*; and
- F. The Grantor attests that the Lands encumbered by this Agreement do not lie within an Agricultural Land Reserve.

THEREFORE THIS AGREEMENT WITNESSES THAT in consideration of the premises, payment of \$10.00 by the Grantee to the Grantor and other good and valuable consideration, the receipt and sufficiency of which each party acknowledges, the parties agree as follows:

ARTICLE 1 - DEFINITIONS

1.01 **Definitions.** In this Agreement, unless the context otherwise requires:

"Amendment" has the meaning set forth in section 6.01;

"Amenities and Services" means the services and amenities, if any, provided by the Grantee to owners of properties within the Resort base area, including but not limited to the Grantor, which may include:

- (a) snow removal services in respect of public access trails and when the service provided by the City is insufficient, public roads;
- (b) landscaping services for Resort areas which are not on private land;
- (c) erection of Resort banners and signage; and
- (d) operation and maintenance services for future public amenities which may include, but are not limited to, a skating rink or Resort tennis courts, if the Grantee, in its sole discretion, provides any of such amenities;

"City" means the City of Revelstoke;

"Development" means any development created on any of the Lands;

"Expenses" means all costs, and expenses incurred by or on behalf of the Grantee in respect of the provision of the Amenities and Services including, without limitation, all taxes payable thereon, amounts paid to any Related Person in respect of the provision of any Amenities and Services and a general administration charge not to exceed 10% of all other costs and expenses;

"Indebtedness" means the Rent Charge, any interest due on arrears and all other amounts payable by the Grantor to the Grantee pursuant to this Agreement;

"Land Title Office" means the Kamloops / Nelson Land Title Office;

"Lands" means those lands and premises described in Item 2 of Part 1, of the Land Title Act Form C to which this Agreement is attached and which forms part of this Agreement;

"Lot" means:

- (a) any individual fee simple parcel resulting from subdivision of the Lands; and
- (b) any strata lot within a building constructed on the Lands or any bare land strata lot created by subdivision of the Lands, in accordance with the *Strata Property Act* (British Columbia) and any amendments, replacements or re-enactments thereof;

"Owner" means any Person who is the registered owner of a Lot subject to this Agreement or another Rent Charge Agreement from time to time;

"Person" means any individual, corporation, body corporate, partnership, joint venture, trust, estate, unincorporated association or other entity or any government or governmental authority however designed or constituted;

"Related Person" in respect of any Person, means:

- (a) any affiliate of such Person, within the meaning of the *Business Corporations Act* (British Columbia) or the *Canada Business Corporations Act*;
- (b) any associate of such Person, within the meaning of the *Business Corporations Act* (British Columbia) or the *Securities Act* (British Columbia); and
- (c) any partnership, including a limited partnership, in which such Person is a partner;

"Rent Charge" means the annual amount payable by the Grantor to the Grantee pursuant to section 3.02, and in addition refers to the charge granted hereby by the Grantor against the Lands to secure payment of the Indebtedness to the Grantee pursuant to this Agreement;

"Rent Charge Agreement" means this Agreement or any similar agreement in respect of lands which form part of the Development whereby use is subject to a rent charge in respect of the Amenities and Services similar to the rent charge provided herein;

"Resort" means all the lands and roads from time to time that comprise Revelstoke Mountain Resort;

"Stipulated Rate" means the Prime Rate plus 12% per annum; and **"Prime Rate"** means that rate of interest per annum designated by the Royal Bank of Canada (or its successor, including by amalgamation or merger) from time to time as the reference rate used by it to set interest rates on commercial loans of Canadian dollars and commonly referred to by such bank as its prime rate, and if at any time Royal Bank of Canada or its successor ceases to exist or ceases to designate a Prime Rate, then the Prime Rate will be the Prime Rate established by the Grantee, acting reasonably; for example, if the Prime Rate is 6% , then the Stipulated Rate would be 18% per annum; and the Stipulated Rate will change whenever the Prime Rate changes; and

"Term" means the initial term of this Agreement as set out in section 4.01 and includes any extension or renewal thereof.

ARTICLE 2 - AMENITIES AND SERVICES

2.01 **Provision of Amenities and Services.** The Grantee will determine, in its sole discretion, the Amenities and Services which it will provide or cause to be provided, having regard to the funds available for the payment thereof from the Rent Charge and other sources and such other factors as may be determined by the Grantee. The Grantee will not be required to provide any Amenities and Services unless they specifically agree to do so in writing and the Grantee will not have any duty, obligation, or liability whatsoever in connection with the provision of the Amenities and Services or the failure to provide or discontinuance of any Amenities and Services.

ARTICLE 3 - THE RENT CHARGE

3.01 **Grant of Rent Charge.** The Grantor, on behalf of itself and all Persons deriving title to the Lands or any portion thereof, it being the intention and agreement of the Grantor that the provisions hereof be

annexed to and run with and be a charge upon the Lands, and each and every portion thereof, hereby conveys and grants to the Grantee in fee simple and charges the Lands with payment of the Rent Charge, including the annual Rent Charge in the amount specified in section 3.02, during the Term. The Rent Charge will commence and be payable in accordance with the terms of this Agreement from and after the date of the granting of this Rent Charge and will continue throughout the Term. The Rent Charge will be a charge upon and will issue and be payable out of the Lands, and each and every Lot created by any subdivision of the Lands or any portion thereof. Notwithstanding the sale, transfer or other disposition of the Lands or any portion thereof, the Rent Charge will survive and the purchaser, transferee or other person acquiring title to the Lands or such portion thereof will be subject to the Rent Charge and this Agreement.

3.02 Calculation of Rent Charge. The Grantee will, in its sole discretion, establish from to time the amount of the annual Rent Charge which will be payable by the Grantor and others in connection with the Grantee's provision of the Amenities and Services. The Rent Charge payable as of the date of this Agreement is set out in Schedule A. The Grantee may revise the Rent Charge, the method of calculation of the Rent Charge and the intervals for the payment of the Rent Charge at any time, upon written notice to the Grantor.

3.03 Assurances re: Rent Charge. The Grantee covenants and agrees that:

- (a) all Rent Charge amounts collected by the Grantee will be applied by the Grantee toward the payment of Expenses and for no other purpose whatsoever;
- (b) the Grantee will not incur Expenses except in accordance with the then current plan and budget, as described in sections 3.05(a) and 3.05(b);
- (c) the Rent Charge amounts will be fair and reasonable, based on the Amenities and Services provided by or on behalf of the Grantee; and
- (d) the annual Rent Charge amounts in respect of the Lands or any portion thereof for any calendar year will not exceed 0.3% of the fair market value of the Lands or any portion thereof, as applicable, including the value of all improvements thereon.

If at any time the Grantor takes the position that the annual Rent Charge amounts for any calendar year exceed 0.3% of the fair market value of the Lands or portion thereof, then:

- (e) the Grantor will deliver to the Grantee a written notice setting out the Grantor's position as to the fair market value of the Lands or portion thereof, together with a written appraisal of the Lands or portion thereof prepared and signed by an appraiser duly qualified and licenced under the laws of British Columbia; and
- (f) for the purposes of section (d), the fair market value of the Lands or portion thereof for the calendar year in which the Grantor's notice was given will be deemed to be the amount set out in the Grantor's notice unless within 60 days after receipt of such notice the Grantee delivers to the Grantor a written notice setting out the Grantee's position of the fair market value of the Lands or portion thereof prepared and signed by an appraiser duly qualified and licenced under the laws of British Columbia, in which case the fair market value of the Lands or any portion thereof for such calendar year will be deemed to be the average of amounts set out in the Grantor's notice and the Grantee's notice,

and after such determination of the fair market value the annual Rent Charge for such calendar year will be reduced by the amount, if any, that it exceeds 0.3% of the fair market value of the Lands or portion thereof.

3.04 GST and Other Taxes. The Grantor will pay all goods and services tax and other taxes payable on the Rent Charge and any other Indebtedness. If required by the Grantee at any time, the Grantor will pay such taxes to the Grantee, in which case the Grantee will be responsible for remitting the taxes collected to the taxing authority.

3.05 Annual Estimates and Reconciliations. The Grantee will estimate the Expenses and the annual Rent Charge for each Lot for each calendar year based on:

- (a) its operating plan for the provision of Amenities and Services; and
- (b) its budgeted Expenses for the provision of Amenities and Services,

and will provide the Grantor with written notice thereof on or before March 15 in each calendar year. Within a reasonable time after the end of each calendar year the Grantee will provide to the Grantor a statement of the actual Expenses for such calendar year, together with a statement as to the actual annual Rent Charge payable for each Lot for such calendar year in accordance with this Agreement, based on the actual Expenses. If such statement shows that the Grantor owes any amount to the Grantee in respect of the annual Rent Charge for such calendar year, the Grantor will pay such amount to the Grantee within 30 days of receipt of such statement. If such statement shows that the Grantee owes any amount to the Grantor in respect of the annual Rent Charge for such calendar year, the Grantee will either pay such amount to the Grantor with such statement or apply such amount as a credit to future annual Rent Charge payments payable by the Grantor, as determined by the Grantee.

3.06 Payment of Monthly Instalments. The Grantor covenants to pay the annual Rent Charge to the Grantee, without set off or deduction, by twelve monthly instalments payable on the first day of each month of each calendar year. Each instalment will be 1/12 of the Rent Charge for that calendar year, as estimated by the Grantee in accordance with section 3.05, subject to the annual adjustment once the Expenses for that calendar year have been determined, as specified in section 3.05. The Grantor will pay the Rent Charge to the Grantee at the address shown above or such other address as the Grantee may advise the Grantor in writing.

3.07 Late Charges and Interest. If a Grantor defaults in the payment of any monthly instalment of the Rent Charge or any portion thereof, then the Grantor will pay to the Grantee any late charge amount determined by the Grantee, in its sole discretion and, in addition, the amount in default will bear interest payable to the Grantee at the Stipulated Rate, compounded monthly and payable daily, and the repayment of such interest will be secured hereby, and the interest will be a charge upon the defaulting Grantor's Lot in the same manner as the Rent Charge. The Grantee will have the same remedies for recovery of such interest if unpaid after demand, as for the Rent Charge. This stipulation for interest will not prejudice or effect any other remedy of the Grantee under Agreement.

3.08 Grantee's Certificates. Upon request of the Grantor or the purchaser or mortgagee of the Lands or any Lot, the Grantee will issue a certificate to such Person within 10 days of such request, certifying:

- (a) the then current annual Rent Charge per Lot; and
- (b) the Indebtedness, if any, of the Grantor at the time of such certificate.

The certificate will be conclusive evidence of any matter certified in it. The Grantee or its agent may charge the Person who requests a certificate under this section a reasonable processing fee for such certificate, which fee will initially be \$25 per certificate and which may be increased from time to time by the Grantee, acting reasonably.

3.09 **Rent Charge to Accrue Day to Day.** The Rent Charge will accrue from day to day.

ARTICLE 4 – TERM

4.01 **Initial Term and Renewal Terms.** Subject to section 4.02, the initial Term of the Rent Charge and this Agreement will be the period commencing on the day this Agreement is registered in the Land Title Office and ending 40 years thereafter, and the Term of the Rent Charge and this Agreement will be automatically extended for an unlimited number of consecutive periods of 10 years each thereafter, unless at the end of any extension the Grantee elects not to extend the Rent Charge and this Agreement further, by written notice to the Grantor of such election or public notice of such election.

4.02 **Discontinuance by Grantee.** The Grantee may elect at any time in its sole and unfettered discretion to discontinue providing the Amenities and Services by giving public notice to such effect. In such event, the Rent Charge will cease and this Agreement will terminate and be at an end as of the effective date set out in such notice and the Grantee will, upon written request by any Owner, execute and deliver to the Owner a discharge of this Agreement in registrable form.

ARTICLE 5 – ENFORCEMENT

5.01 **Power of Entry and Distraint.** If the Grantor defaults in payment of any instalment of the Rent Charge or any other amount payable under this Agreement in respect of any Lot for the period of 60 days after the due date, then at any time after that date and without further notice, the Grantee may enter upon such Lot and may distraint upon any property, including, without limitation, the Lot and any improvements thereon, for the amount in arrears and may exercise all powers of distress, including the power to sell such property to satisfy the amount owing.

5.02 **Power of Sale.** If the Grantor defaults in payment of any instalment of the Rent Charge or other amount payable under this Agreement in respect of any Lot for the period of 180 days after the due date, then the Grantee may, at any time thereafter, sell and absolutely dispose of such Lot, either by public auction or private contract, on such terms and conditions as the Grantee determines; and the Grantee may enter into, complete, rescind or vary any contract or sale or resale without being responsible for any loss occasioned thereby, and may convey and assure the Lot to the purchaser in fee simple and the Grantor hereby constitutes the Grantee, its successors and assigns, the attorney or attorneys irrevocable by death or otherwise, of the Grantor, its heirs, executors, administrators, successors or assigns, to make such conveyance or conveyances provided that:

- (a) such power of sale must not be exercised until after one month's notice in writing has been given to the Grantor, either by delivery to the Grantor, or by delivery to an adult Person resident or in occupation of the Lot, or if the Lot is vacant by substituted service in the manner allowed under the Supreme Court Rules of the Province of British Columbia or any enactment in replacement thereof; and
- (b) the Grantor does not, before the Grantee completes any contract for the sale of the Lot, pay the amount in default, with interest thereon, together with all expenses incurred by

the Grantee in connection with any such notice and proceedings of sale or otherwise in relation to the Lot, including legal costs on a solicitor and own client basis.

5.03 Survival of Rent Charge. Despite any transfer or other disposition in fee simple of any Lot, whether under section 5.02 or otherwise, in respect of which the Rent Charge or any amount payable under this Agreement is in default, the Rent Charge will survive and the purchaser in fee simple will be subject to the terms of this Agreement. The transfer or other disposition in fee simple of a Lot under section 5.02 or otherwise will, as regards to the purchaser, be deemed to be valid despite any impropriety or irregularity with respect to the sale of the Lot to the purchaser and the remedy, if any, of the Grantee in respect of any impropriety or irregularity of any sale will be in damages only, and the purchaser on any sale will not be required to see the application of the proceeds of the sale or be accountable for any loss, misappropriation or misapplication thereof.

5.04 Application of Proceeds of Sale. The money realized by reason of any sale described in section 5.02 or otherwise will be applied by the Grantee:

- (a) first, in payment of the expenses incurred by the Grantee in connection with the enforcement of the Rent Charge, the proceedings of sale, the sale or otherwise in relation to the Lot, including realtor's fees and legal costs on a solicitor and own client basis;
- (b) second, in satisfaction of the Rent Charge with interest thereon and other amounts then owing and secured by this Agreement;
- (c) third, to discharge any mortgages or liens registered against title not assumed by the purchaser; and
- (d) fourth, the balance, if any, to the Grantor or as the Grantor directs.

5.05 Other Remedies. In addition to the above provisions for enforcement of the Rent Charge and other amounts due under this Agreement, the Grantee, at its option, may bring or take legal action for payment or to compel a mortgage or for foreclosure in a court of competent jurisdiction or may exercise any and all other remedies of a rent charge holder at law or in equity. All of the remedies of the Grantee will be cumulative and will be in addition to every other remedy available to the Grantee and all such remedies and powers of the Grantee may be exercised concurrently from time to time. If the Grantee exercises or attempts to exercise any of its remedies, the Grantor will pay all of the costs incurred by the Grantee in so doing, including the Grantee's legal costs on a solicitor and own client basis.

5.06 Lot by Lot Basis. Notwithstanding the foregoing provisions for enforcement of the Rent Charge and other amounts due under this Agreement, the Grantee agrees that once the Lands are subdivided as contemplated by the definition of "Lot", the Grantee will only exercise its rights and remedies in case of default against the Owner who is in default and against such Owner's Lot, but not against any other Owner or Lot.

5.07 Exclusion or Exemption by Grantee. The Grantee will have the right to exclude or exempt any Lot, including any Lot owned by the Grantee, from the Rent Charge for such period as the Grantee may determine or discharge this Agreement from any Lot where in the opinion of the Grantee the circumstances warrant such exclusion, exemption, or discharge. The Grantee will also have the right to limit the amount of the Rent Charge applicable to any Lot, including any Lot owned by the Grantee, for such period and on such terms as the Grantee may determine where in the opinion of the Grantee the circumstances warrant such limit.

ARTICLE 6 -AMENDMENTS AND SUBDIVISION

6.01 **Grantee's Amendments.** The Grantee may propose amendments to this Agreement which in its opinion are necessary because of changes in the law or to implement and carry out the true intent and meaning of this Agreement. The Grantee will give notice of any such proposed amendment (the "**Amendment**") to each Owner in accordance with section 7.01. An Owner may object to the Amendment by providing written notice of such objection to the Grantee within 10 days of receipt or deemed receipt from the Grantee of the notice of the Amendment. All Owners will be bound by the Amendment if the Owners who have objected to the Amendment by way of notice as herein provided represent in the aggregate less than a majority of all Owners. An Amendment will not become effective and binding on the Owners if a majority of the Owners by notice as herein provided object thereto. Where a Lot is owned by more than one Person, then for the purpose of this section all such Persons will comprise the Owner and will have a single vote.

6.02 **Amendments to Other Rent Charges.** Notwithstanding section 6.01, this Agreement will not be amended in the manner set out herein unless every other Rent Charge Agreement in effect is also amended in similar manner.

6.03 **Subdivision.** If the Lands are subdivided, either wholly or in part, at any time, either under the provisions of the *Land Title Act* (British Columbia) or the *Strata Property Act* (British Columbia), as amended from time to time, or other similar legislation enacted from time to time, on the deposit of a plan of subdivision, strata plan or similar plan, as the case may be, this Agreement and the Rent Charge will run with and continue to be a charge upon each of the new parcels, lots, strata lots or other subdivided parcels shown on such plan and the remainder, if any, of the Lands subdivided, and will be read and construed *mutatis mutandis*. No consent of the Grantor or the owner or owners of the Lands to any such subdivision will be required but, nevertheless, without restricting the generality of the foregoing, the Grantor and the Grantee covenant and agree each with the other that each will execute and deliver in registrable form any and all documents and plans, and that will do all things, reasonably necessary in order to give effect to section.

ARTICLE 7 – NOTICES

7.01 **Notices.** Any notice, invoice, demand, or other communication required to be given hereunder will be in writing and may be sufficiently given by personal delivery, email or by fax to the party receiving the same and will be deemed to have been given and received on the day of delivery, email, or fax. Any notice may also be given by prepaid registered mail within the Province of British Columbia by the party giving the same to the party receiving the same at the address of the party to whom such notice, invoice demand, or other communication is to be given appearing in the records of the Land Title Office and will be deemed to have been given and received on the fifth day following mailing, except in the event that there will be a disruption in postal services at the date of mailing, in which case notice will be effected by personal delivery or by fax as stated above. In the case of any notice to the Grantee, a notice must also be given to Grantee at the following address:

Revelstoke Mountain Resort Inc.
P.O. Box 2460 204B 1st Street West Revelstoke, B.C. V0E2S0
Fax No.: (250) 837-4675
E-Mail: _____
Attention: President

ARTICLE 8 – GENERAL

8.01 **Number and Gender.** Singular words contained herein will be read to include the plural and masculine words will be read to include the feminine and the neuter, and *vice versa*.

8.02 **Delegation by Grantee.** The Grantee may at any time and from time to time delegate to any Person (including, without limitation, any Related Person) any of its rights, duties, and obligations hereunder.

8.03 **Time of the Essence.** Time will be of the essence of this Agreement.

8.04 **Governing Law.** This Agreement will be governed by the laws of the Province of British Columbia.

8.05 **Non-Limiting.** The word "including"; when following any general statement, will be construed to refer to all other things that could reasonably fall within the scope of such general statement, whether or not non-limiting language (such as "without limitation", or "without limiting the generality of the foregoing") is used with reference thereto.

8.06 **No Waiver.** No failure or delay on the part of the Grantee in exercising any right, power, or privilege under or in respect of this Agreement will operate as a waiver thereof, nor will any single or partial exercise of any right, power or privilege preclude any other or further exercise thereof or the exercise of any other right, power, or privilege. Except as may be expressly limited herein, the Grantee may, in its sole discretion, exercise any and all rights, powers, remedies and recourses available to it under or in respect of this Agreement or any other agreement and such rights, powers, remedies and recourses may be exercised concurrently or individually without the necessity of making any election.

8.07 **Further Assurances.** The Grantor hereto will at all times and from time to time upon reasonable request by the Grantee execute and deliver such further and other documents and instruments and do and perform such further and other acts and things as may be reasonably required by the Grantee for the purpose of evidencing or giving full force and effect to the provisions or intent of this Agreement.

8.08 **Joint and Several.** If the Grantor is comprised of more than one person, then all of the covenants, agreements, representations, and warranties of each person comprising the Grantor will be joint and several covenants, agreements, representations, and warranties.

8.09 **Severability.** If any term or provision hereof is judicially declared to be invalid, illegal, or unenforceable, that term or provision will be severed from this Agreement and will not affect the validity, legality, or enforceability of any of the remaining terms and provisions hereof.

8.10 **Perpetuities.** To the extent the rule against perpetuities applies to this Agreement or any right, power or enforcement remedy provided for herein, then the perpetuity period be 80 years from the grant hereof or such longer period as may be provided by law.

8.11 **Assignment by Grantee.** The Grantee will have the right to assign to any Person (including any Related Person) this Agreement provided that such Person assumes the obligations of the Grantee hereunder. Upon such assignment being made, the assignor will be relieved of all of its obligations hereunder and all references to the Grantee will thereafter be construed as references to the assignee.

8.12 **Enurement.** The covenants contained herein will enure to and be for the benefit and will be binding upon the Grantee, its successors and assigns and will be annexed to and run with and be a charge

upon the Lands, and each and every portion then

ARTICLE 9 – 219 COVENANT

9.01 **Section 219 Covenant.** The Grantor shall not make use of the Lands or a Lot unless it pays the Grantee the annual Rent Charge during the Term of this Agreement, without deduction or set-off whatsoever.

As evidence of their agreement to be bound by this Agreement, the parties have executed the Land Title Act Form C attached to and forming part of this Agreement.

SCHEDULE A

RENT CHARGE AMOUNTS

The Grantee has not yet established the Rent Charge amounts.

In addition to the Rent Charge, the following charges will apply:

- Late Payment Charge: \$10.00 per occurrence (plus interest at the Stipulated Rate)
- NSF or returned cheque charge: \$25.00 per NSF or return cheque

Notes:

1. The above Rent Charge amounts are those in effect as of the date of this Agreement. The Grantee may change or supplement any of the foregoing at any time, in accordance with any requirements set out in this Agreement.
2. The Grantor will pay all GST and other taxes and charges payable on all Rent Charge amounts.

- END OF DOCUMENT -

Schedule "H"
Rental Restriction Covenant

TERMS OF INSTRUMENT – PART 2

RESTRICTIVE COVENANT

WHEREAS:

- A. The Transferor is the registered owner in fee simple of those certain parcel(s) of land situated in the City of Revelstoke, in the Province of British Columbia, legally described as:

(the “**Transferor’s Lands**”)

- B. The Transferee is the registered owner in fee simple of those certain parcel(s) of land situated in the City of Revelstoke, in the Province of British Columbia, legally described as:

(the “**Transferee’s Lands**”)

- C. The Transferor’s Lands will be developed as part of a larger resort community by the Transferee.
- D. The parties acknowledge that this Covenant is necessary in order to ensure that all residential accommodation built on the Transferor’s Lands be available for commercial rental to the public in a manner which meets the standard of a high-quality resort and maximizes the number of people occupying such accommodation.

In consideration of the covenants contained in this Covenant and for other valuable consideration, the receipt and sufficiency of which are acknowledged by the parties, the parties covenant and agree with each other as follows:

1. DEFINITIONS

1.1. In this Covenant:

- (a) “Covenant” means this entire instrument, including the Form C- General Instrument Part 1 attached, and this Section 221 Restrictive Covenant;
- (b) “Personal Use” means the non-commercial use of a Unit by the Unit Owner as a recreational or seasonal residence;
- (c) “Public” means all persons other than the Unit Owner;
- (d) “Registered Owner” means the person registered in the Land Title Office as the owner in fee simple of the Unit or, where there is a registered agreement for sale of the Unit, the registered holder of the last registered agreement for sale;
- (e) “Rental Manager” means the Transferee;
- (f) “Rental Management Agreement” means the agreement made between the Registered Owner and the Rental Manager setting out the terms by which the Rental Manager will manage and make the Unit available for Rental Use in the form attached as Schedule A;
- (g) “Rental Use” means the commercial use of a Unit for rental to the Public;
- (h) “Season” means the Summer Season and the Winter Season;

- (i) "Summer Season" means the period from and including May 15th to and including November 14th of each calendar year;
- (j) "Unit" means a unit of residential accommodation on the Transferor's Lands;
- (k) "Unit Owner" means the Registered Owner(s) of a Unit and the spouse, children and parents of such Registered Owner(s) and the parents of the Registered Owner(s)' spouse; and, where the Registered Owner(s) is a corporation or corporations, all directors, officers, shareholders and employees and the spouses, children and parents of each of them will together with the corporation or corporations constitute the "Unit Owner" for that Unit and "Unit Owner" shall include any person permitted by any as the foregoing to use the Unit free of charge;
- (l) "Use" or "Used" in relation to any Unit includes the purpose to which the Unit is put and includes reside, sleep, inhabit, or otherwise occupy;
- (m) "Winter Season" means the period from and including November 15th to and including May 14th of each calendar year.

2. **RESTRICTION ON RENTAL USE**

2.1. **Rental Use.** The Transferor covenants and agrees with the Transferee that the Unit shall not be used as or occupied for Rental Use during the Season and that no Registered Owner will permit its Unit to be used as or occupied for Rental Use during the Season except in accordance with each of the following:

- (a) this Covenant; and
- (b) the Rental Management Agreement.

2.2. **Rental Management Agreement.** The terms of the Rental Management Agreement are as set out in Schedule A. Any amendments to the Rental Management Agreement must be in writing and the parties agree to execute, deliver and register any documents or instruments necessary to ensure the enforceability of this Covenant.

3. **SALE OF UNIT**

3.1. **Proposed Sale.** In the event the Transferor wishes to sell or otherwise directly or indirectly dispose of the Unit, the Transferor will notify the Rental Manager in writing prior to selling or otherwise disposing of the Unit.

3.2. **Notice to Purchaser.** Prior to selling or otherwise disposing of the Unit, the Transferor will notify proposed purchasers of this Covenant and the Rental Management Agreement and their obligation to comply with the Covenant and enter into the Rental Management Agreement.

3.3. **Purchaser's Execution.** At the time of the closing of the purchase of a Unit, the purchaser shall enter into the Rental Management Agreement, failing which such purchaser shall be deemed to have done so for purposes of this Covenant upon becoming the Registered Owner of such Unit.

4. **TERMINATION**

4.1. This Covenant may be terminated only by mutual written agreement between the Transferor and the Transferee and upon such agreement the parties shall execute and deliver any document or instrument required to register a discharge of the Covenant at the Land Title Office.

5. **DISPUTE RESOLUTION**

5.1. Any of the parties to this Covenant shall refer to arbitration for any dispute about the interpretation or enforcement of this Agreement. Notice shall be given by the party desiring the arbitration to all parties with whom that party is having a dispute or disagreement and within two weeks after notice is received, the parties shall agree upon and appoint a single arbitrator. Provided, however if they cannot

agree upon a single arbitrator, each party shall within one further week appoint an arbitrator and the two arbitrators so appointed shall within one further week appoint a single arbitrator who shall be the sole arbitrator of the proceedings. The arbitrator shall hear the reference as soon as possible at a convenient location in the City of Revelstoke, British Columbia. The arbitrator may accept evidence on oath, affidavit or otherwise as they believe proper whether or not admissible in a court. Any award or order rendered by the arbitrator shall be final, conclusive and binding upon the parties and judgment may be entered on the arbitrator's award or order in any court having jurisdiction. The expenses of such mediation or arbitration shall be borne equally by the parties, except that each party shall be entirely responsible for its own legal fees and its nominee expenses, regardless of the outcome of the mediation or arbitration.

6. **GENERAL**

- 6.1. **Binding Covenant and Enurement.** Pursuant to Section 221 of the *Land Title Act*, the restrictions and covenants in this Covenant shall be perpetual and run with and burden the Transferor's Lands, as servient tenement, and bind the owner of the Transferor's Lands and its heirs, executors, administrators, assigns and successors in title to the Transferor's Lands, for the benefit of the Transferee's Lands, as dominant tenement, and the owner of the Transferee's Lands and its heirs, executors, administrators, assigns and successors in title to the Transferee's Lands.
- 6.2. **No Waiver.** Any delay or failure by the Transferee to insist upon the strict performance of any term of this Covenant, or to exercise any term, right or remedy contained in this Covenant or available to it in law or in equity will not be construed as a waiver or relinquishment by the Transferee for the future of that term, right or remedy. No term, condition, covenant or other provision of this Covenant will be considered to have been waived by the Transferee unless the waiver is expressed in writing by the Transferee.
- 6.3. **Interpretation.** Wherever the expression "Transferor" and "Transferee" are used, the same shall be construed as meaning the plural, all genders or non-genders, body corporate or politic where the context of the parties so require.
- 6.4. **Joint and Several.** If the Transferor or Transferee is more than one person, all of the covenants and liabilities of the Transferor or Transferee, as applicable, are joint and several.
- 6.5. **When Non-Binding.** The covenants of the Transferor contained in this Covenant will be personal and binding upon the Transferor in respect of the Transferor's Lands only during the Transferor's ownership of any interest in the Transferor's Lands.
- 6.6. **No Modification.** The parties agree that this Covenant will not be modified or discharged without written consent of the parties.
- 6.7. **Governing Laws.** This Covenant will be governed by and construed in accordance with the laws of British Columbia and the federal laws of Canada, as applicable.
- 6.8. **Severability.** If any section, subsection, sentence, clause or phrase in this Covenant is for any reason held to be invalid by a court of competent jurisdiction, the invalid portion shall be severed and the provision that is invalid shall not affect the validity of the remainder of this Covenant.
- 6.9. **Further Assurances.** The Transferor will do or cause to be done all things and execute or cause to be executed all documents and give such further and other assurances which may be reasonably necessary to give effect to the intent of the Covenant.

SCHEDULE A

RENTAL MANAGEMENT AGREEMENT
REVELSTOKE MOUNTAIN RESORT

This Agreement dated as of the _____ day of _____, 20_____.

BETWEEN:

Name:	_____	Name:	_____
Address:	_____	Address:	_____
Telephone:	_____	Telephone:	_____
E-mail:	_____	E-mail:	_____
GST Number:	_____		

(collectively, the "Owner")

AND:

REVELSTOKE ALPINE VILLAGE INC.

2950 Camozzi Road
Revelstoke, BC V0E 2S0
E-mail: _____
Telephone: _____

(the "Manager")

"Unit": _____, including any limited common property or common property rights of the Unit, as applicable.

The Owner hereby certifies that the Owner [] is a resident of Canada [] is not a resident of Canada for the purposes of the *Income Tax Act* (Canada) and agrees to inform the Manager of any change of residency.

BACKGROUND:

- A. The Owner is the registered owner of the Unit located at Revelstoke Mountain Resort (the "Resort") in Revelstoke, British Columbia, Canada.
- B. The Resort is a world-renowned ski resort complete with summer and winter recreational activities, social amenities and community spaces used by owners at the Resort and visitors from around the world.

- C. Subject to the Rental Covenant, the Owner has the full right, title, power and authority to offer the Unit for rental and desires to appoint the Manager as its agent for the rental of the Unit upon the terms and conditions set out in this Agreement.
- D. The Manager has agreed to become the Owner's agent in respect of the management of the rental of the Unit on the terms and conditions contained in this Agreement.

THEREFORE, in consideration of the mutual covenants and conditions contained in this Agreement, and other good and valuable consideration, the receipt and sufficiency of which is hereby acknowledged, the parties agree as follows:

AGREEMENT:

1. DEFINITIONS

1.1. In this Agreement, the following terms have the following meanings:

- (a) **"Adjusted Gross Revenue"** means the Gross Revenue less the Credit Card Commission, any Reservation System/Affiliation Fee (if applicable), booking commissions to travel agents and wholesalers, all goods and services tax, room tax and other applicable taxes payable with respect to the rental of the Unit and all other reasonable expenses;
- (b) **"City"** means the City of Revelstoke;
- (c) **"Credit Card Commission"** means a percentage charged by the credit card company from time to time as a processing fee for transactions paid by credit card;
- (d) **"Development"** means the strata or subdivision project in which the Unit is located;
- (e) **"Financial Information"** means the financial information pertaining to the Unit during the Rental Period, including any deductions withheld and remitted in accordance with Section 3.3;
- (f) **"Financial Records"** has the meaning set out in Section 5.1(j);
- (g) **"Gross Revenue"** means all amounts collected by the Manager in connection with the rental of the Unit (including, without limitation, all amounts collected by the Manager for the rental of parking stalls), except for money paid for specific services, such as Owner's Departure Cleaning Charge, valet and special housekeeping charges, payment for ski rentals or tickets, viewing movies, vending machine use, coin-operated laundry, crib or cot rental and any other services which the Manager may provide in addition to the rental of the Unit;
- (h) **"Management Fee"** means the management fee payable to the Manager, as described in Section 4.1;
- (i) **"Owner's Annual Interior Deep Cleaning Charge"** means the fee charged by the Manager to the Owner for the annual interior deep cleaning of the Unit provided by the Manager in accordance with Section 5.2;
- (j) **"Owner's Annual Routine Maintenance Charge"** means the fee charged by the Manager to the Owner for the routine maintenance services provided by the Manager pursuant to Section 5.3;

- (k) “**Owner's Departure Cleaning Charge**” means the fee charged by the Manager to the Owner following a period of personal use of the Unit by the Owner in accordance with Section 7.3;
 - (l) “**Owner's Net Rental Revenue**” means the Gross Revenue less the Management Fee, Owner's Departure Cleaning Charge, Owner's Annual Interior Deep Cleaning Charge and Owner's Annual Routine Maintenance Charge (in each case as applicable), monthly other amounts deductible from Owner's Net Rental Revenue as provided for in this Agreement, except those that have already been deducted in accordance with the Adjusted Gross Revenue;
 - (m) “**Owner's Usage**” means the deep cleaning period and other periods when an Owner or family and friends of an Owner are occupying the Unit during a Rental Period;
 - (n) “**Personal Use**” means the non-commercial use of the Unit by the Owner as a recreational or seasonal residence in accordance with Section 2.2;
 - (o) “**Public**” means all persons other than the Owner;
 - (p) “**Rental Covenant**” means the restrictive covenant registered against title to the Unit in favour of the lands owned by the Manager in respect of the rental of the Unit;
 - (q) “**Rental Period**” means the period(s) of time during the Term that the Owner elects to rent the Unit under this Agreement in accordance with Article 2;
 - (r) “**Rental Operating Account**” has the meaning set out in Section 3.1;
 - (s) “**Reservation System/Affiliation Fee**” means a fee charged by the Manager to recover from the Owners any amount or a portion of any amount payable in respect of franchise, affiliation, reservation system or other similar service arrangements engaged in or entered into by the Manager for the benefit of the rental of the Unit;
 - (t) “**Season**” means the Summer Season or the Winter Season, as the case may be;
 - (u) “**Summer Season**” means each period from and including May 15th to and including November 14th during the Term;
 - (v) “**Term**” means the term of this Agreement, as determined in accordance with Section 2.7, and includes any Renewal Term, as applicable;
 - (w) “**Units**” means all units available for rental, subject to the Rental Covenant and a rental management agreement, within the Resort; and
 - (x) “**Winter Season**” means each period from and including November 15th to and including May 14th during the Term.
- 1.2. For the purposes of this Agreement, a Unit will be considered capable of rental on any particular day and the Owner will be able to collect the Owner's Net Rental Revenue for that day if the Owner has elected to rent the Unit in accordance with Section 2.3, the Unit is not being used by the Owner for personal use in accordance with Section 7.1, and the Unit is, in the reasonable opinion of the Manager, fit for occupancy by renters.

2. **MANAGEMENT, USE, TERM AND TERMINATION**

- 2.1. **Appointment and Management.** The Owner appoints the Manager as its exclusive agent to manage the rental of the Unit in accordance with the terms and conditions set out in this Agreement. The Manager accepts such appointment and shall serve as the exclusive rental manager for the Unit in accordance with this Agreement.
- 2.2. **Not Required to Rent.** The Owner and the Manager agree that notwithstanding the execution and delivery of this Agreement, the Owner is not required to make the Unit available for rent to the Public and that as long as the Owner is using the Unit for Personal Use the terms of this Agreement pertaining to the rental of the Unit shall not apply.
- 2.3. **Election To Rent.** At any time, the Owner may elect to make the Unit available for rent to the Public. Upon electing to make the Unit available for rent the Owner shall notify the Manager in the form attached as Schedule A and upon the receipt of such notice by the Manager the terms of this Agreement with respect to rental management shall be in effect and the Manager will manage the rental of the Unit in accordance with this Agreement.
- 2.4. **Election to Not Rent.** The Owner may remove its Unit from availability for rental to the Public on written notice to the Manager, provided the Owner remains bound by all rental bookings made by the Manager as of the date of such notice. Upon the Owner wishing to rent the Unit again to the Public, the Owner must give notice to the Manager in accordance with Section 2.3 to re-instate the rental management of the Unit.
- 2.5. **Rental Manager.** The Owner acknowledges and agrees that the Manager will manage the rental of the Unit in accordance with this Agreement. The Owner hereby irrevocably covenants and agrees to be bound before and after termination of this Agreement by the rental bookings of the Unit made by the Manager in accordance with this Agreement. The Owner will indemnify and save the Manager harmless from all claims, damages and costs in connection with any failure of the Owner, or anyone claiming under or on behalf of the Owner, to comply with such rental bookings.
- 2.6. **Use.** The Unit will be rented for short term vacation use only in accordance with this Agreement and will not be used for any other purpose except in accordance with arrangements agreed to in advance between the Owner and the Manager. Any use of the Unit will comply with all applicable laws and the bylaws, rules, regulations, and documents registered against title to the Unit.
- 2.7. **Term.** The term of this Agreement will be for a period of ten (10) years from the date of this Agreement up to and including April 30, 20____ (the "Term"), subject to any renewal set out in Section 2.8, unless terminated earlier in accordance with this Agreement.
- 2.8. **Automatic Renewal.** The Term shall automatically renew for five (5) successive renewal terms of ten (10) years each (the "Renewal Term"), unless terminated earlier in accordance with this Agreement. Each Renewal Term will be on the same terms and conditions as this Agreement.
- 2.9. **Manager's Right to Terminate.** The Manager may terminate this Agreement if the Owner fails to keep, observe, or perform any material covenant, agreement, term or provision to be kept, observed, or performed by the Owner under this Agreement, and such default continues for a period of 45 days after the Owner's receipt of written notice from the Manager requesting the cure of such default, or if such default is of such a nature that it cannot be cured by the Owner within such 45 day period if the Owner fails to commence to cure such default within 14 days of receipt of such notice or thereafter to proceed diligently and continuously to cure such default; provided this termination shall be suspended during an arbitration of a dispute as to a default under this Section 2.9 until the decision of the arbitrator(s) is delivered.

- 2.10. **Owner's Right to Terminate.** The Owner may terminate this Agreement if any of the following events occur:
- (a) the Manager fails to keep, observe, or perform any material covenant, agreement, term or provision to be kept, observed, or performed by the Manager under this Agreement, and such default continues for a period of 45 days after the Manager's receipt of written notice from the Owner requesting the cure of such default, or if such default is of such a nature that it cannot be cured by the Manager within such 45 day period if the Manager fails to commence to cure such default within 14 days of receipt of such notice or thereafter to proceed diligently and continuously to cure such default; provided this termination shall be suspended during an arbitration of a dispute as to a default under this Section 2.10(a) until the decision of the arbitrator(s) is delivered;
 - (b) the Manager files a petition in bankruptcy, any proposal for reorganization, or for an arrangement under any bankruptcy or insolvency laws, or if any petition under any such law is filed by any third party against the Manager and not dismissed within 60 days; or
 - (c) the Manager makes any assignment of its property for the benefit of the Manager's creditors.
- 2.11. **Events upon Termination.** Upon providing or receiving a notice of termination, and upon the actual termination or expiry of this Agreement:
- (a) the Manager will not make any further rental bookings of the Unit;
 - (b) the Manager may, at its discretion, transfer any existing rental bookings of the Unit to any other rental unit within the Resort and the Owner acknowledges that such rental bookings will have been made due to the efforts made and the expenses incurred by the Manager and will remain the property of the Manager following termination;
 - (c) if the Manager does not transfer the rental bookings of the Unit pursuant to Section 2.11(b), the Owner will continue to be bound by the rental bookings made by the Manager in accordance with this Agreement including those which extend beyond the date of the termination or expiry of this Agreement and will indemnify and hold harmless the Manager in respect of such rental bookings and the Manager will be entitled to receive the Management Fee and any other amount owing under this Agreement in respect of such rental bookings; and
 - (d) following the expiry or termination of this Agreement, the Manager will account to the Owner for the money collected on behalf of the Owner in the Rental Operating Account and held by the Manager and will continue to be held for a period of 60 days after the expiration or termination of this Agreement and during this period the Manager may make withdrawals and payments from the Rental Operating Account with respect to any amount the Manager is authorized or required to pay pursuant to this Agreement, including the Management Fee and any other amount payable to the Manager under this Agreement, and the Owner will reimburse the Manager for such amounts to the extent that funds held in the Rental Operating Account on behalf of the Owner are insufficient for this purpose.
- 2.12. **Assignment by Manager.** The Manager will, on delivery of at least 180 days prior written notice to the Owner, have the right to assign its interest in this Agreement and have its obligations under the Agreement assumed by a professional rental operator of equal or greater managerial capacity and ability to that of the Manager provided such assignee assumes the obligations of the Manager under this Agreement and all of the other rental management agreements for the Units. For the purposes of this Agreement, "managerial

capacity and ability” means the overall ability and capacity of a rental management company based on:

- (a) international recognition of its trademark, trade name, service mark and copyright to be used in connection with the marketing and operation of the Resort as a luxury resort of its size and location;
- (b) its financial status;
- (c) the size and geographic distribution of its reservation system among potential guests of the Resort;
- (d) the perceived operating standards of rental units managed by it under the same trademark and trade name which it would use for the Resort;
- (e) a reasonable estimate of its ability to maintain or increase the Owner’s Net Rental Revenue over that which would have been produced by the Manager for the balance of the period under the Agreement under the same conditions; and
- (f) its ability to provide competent personnel experienced in the hospitality industry to manage and operate the Resort.

Satisfaction of the foregoing test will be determined by the Manager in its sole discretion.

3. **RENTAL OPERATING ACCOUNT AND OWNER’S REVENUE**

- 3.1. **Rental Operating Account.** The Manager will maintain an account or accounts in respect of its rental management obligations under this Agreement in a financial institution qualified to engage in the banking business in British Columbia. The Owner acknowledges and agrees that the Rental Operating Account may contain funds in respect of the rental of other Units within the Resort and that the Owner’s funds may be commingled with the funds of other owners. The Manager will deposit and disburse the amounts associated with the rental bookings under this Agreement from the Rental Operating Account. The obligation of the Manager to disburse funds and carry out the obligations imposed by this Agreement is conditional upon sufficient funds being available from the Gross Revenue or from the Owner's resources. All interest earned on the Rental Operating Account will be for the Manager's benefit and account.
- 3.2. **Payment to Owner.** The Manager will pay to the Owner the Owner’s Net Rental Revenue in the Rental Operating Account on a monthly basis, provided the Owner’s Net Rental Revenue exceeds \$100. Such payment will be made by the Manager to the Owner by way of e-transfer. The Manager shall provide written notification of the e-transfer to the Owner, which will include a written statement prepared by the Manager setting out the Gross Revenue, Adjusted Gross Revenue, Owner's Net Rental Revenue, and all applicable deductions.
- 3.3. **G.S.T. and Withholding Tax.** The Owner will be responsible for the payment of the goods and services tax and other applicable taxes, charges, rates and levies payable by the Owner in connection with the Unit or this Agreement, including, without limitation, that payable in connection with the Management Fee (other than income tax or withhold tax on the Management Fee itself). The Owner authorizes and agrees that the Manager may withhold from the Owner’s Net Rental Revenue and remit to Revenue Canada, or any other relevant authority, any amount required to be withheld or remitted in respect of goods and services tax, non-resident or other withholding tax or any other applicable tax, charge, rate or levy which the Manager is required to remit.
- 3.4. **Reporting.** The Manager will provide the Owner with an annual statement of the Financial Information within a reasonable period of time at the end of each Term year.

3.5. **Owner/Manager Costs.** Schedule B is attached to this Agreement as a convenient, information only, summary of the respective responsibilities of the Owner and the Manager for commonly occurring costs and does not amend the specific terms of this Agreement. If any specific term of this Agreement conflicts with Schedule B, the specific term will supersede the Schedule.

4. **COMPENSATION OF MANAGER**

4.1. **Management Fee.** As compensation for the services provided by the Manager under this Agreement, the Owner will pay to the Manager a monthly management fee of 30% of the Adjusted Gross Revenue for each month during the Term. The Manager may increase the Management Fee and adjust the level of services provided by the Manager, in the Manager's discretion, upon 6 months written notice to the Owner prior to the commencement of a Season; Provided, however, that such increase may not occur more than once in any Season during the Term.

5. **MANAGER's OBLIGATIONS**

5.1. **Manager's Responsibilities.** During the Term, the Manager will:

- (a) retain the right to the use of the Manager's reservation/booking system;
- (b) use reasonable efforts to rent the Unit during the Rental Period;
- (c) operate, supervise, manage, maintain, control and rent the Unit in such a manner as would a prudent manager of a rental unit similar to the Unit within a similar development as the Resort;
- (d) annually determine the rate of rental for the Unit having regard to the seasonal uses of the Unit, the market for the rental of units similar in quality and value to the Unit and the optimization of the Owner's revenue. Attached as Schedule C is the Manager's current pricing management guidelines, which may be modified by the Manager from time to time in the Manager's sole discretion;
- (e) collect all rents, fees and other amounts payable in connection with the rental of the Unit, give receipts and acknowledgements of such amounts, and if reasonable, make abatements and allowances in respect of such amounts;
- (f) charge the renters of the Unit for all long-distance telephone calls made from the Unit by such renters, and remit all amounts collected on behalf of the Owner to the applicable telephone utility;
- (g) check-in all renters at the Manager's front desk facility, if applicable;
- (h) provide renters with any information regarding the Resort's and Unit's rules, bylaws, notices or other applicable policies, guidelines, or documents governing the use of the Unit and common areas at the Resort (collectively, the "Resort Policies");
- (i) at the Manager's sole cost and expense, replace from time to time towels, house linens and housewares such as glasses, cups, saucers, bowls, plates and cutlery and similar in-suite items, in each case which such items are worn out or damaged as a result of normal wear and tear and not through misuse or abuse by the Owner during a period of the Owner's Personal Use or Owner's Usage, and generally provide those services customarily provided by managers operating similar rental management businesses or operations on terms and conditions similar to those contained in this Agreement (including the Management Fee);
- (j) keep or cause to be kept full and adequate books of account and such other reasonable records reflecting the Rental Operating Account, Gross Revenue, Adjusted Gross

Revenue, Owner's Net Rental Revenue and all deductions therefrom, including the Management Fee (the "Financial Records");

- (k) permit the Owner during normal business hours and on reasonable notice, to examine or make copies of the Financial Records of the Unit at the Manager's office, but such examination will be done at the cost of the Owner and with as little disruption as possible to the day to day operations of the Manager;
- (l) warn off and prohibit and proceed against any person who trespasses upon the Unit or any part of the Unit with the knowledge of the Manager by due process of law as the Manager may deem appropriate, either before or after such warning off or prohibition;
- (m) use reasonable efforts to ensure that the Unit and its use and occupancy comply with all fire and safety codes, rules and requirements of all governmental or regulatory authorities, including the bylaws and applicable rules and regulations of the strata corporation, if applicable, subject at all times to the duties of the Owner as the owner of the Unit and provided that the Manager will not be obligated to advance or utilize any of its own funds in respect of the foregoing;
- (n) take out and maintain at all times during the Term the following insurance pertaining to the rental management business and operations of the Manager:
 - (i) comprehensive public liability insurance in an amount of at least \$2,000,000 for claims for personal injury, death or property damage arising out of any single occurrence;
 - (ii) any innkeeper's liability, worker's compensation or other similar insurance as may be required by law;
 - (iii) such other insurance as the Manager may determine to be necessary or desirable from time to time;
- (o) faithfully perform its duties and responsibilities under this Agreement and otherwise use its best efforts to supervise and direct the rental of the Unit in an efficient and profitable manner consistent with the standard of the Resort, it being the intention of the parties that the Manager will have control of and discretion with respect to the rental of the Unit for the purposes permitted under this Agreement and the right to determine all operating policies with respect to reasonable standard of operations, quality of services and any other matters affecting the rental of the Unit;
- (p) procure and maintain all such licences and permits as are necessary in connection with the performance by the Manager of its obligations under this Agreement;
- (q) provide such general administrative, supervisory and management staff and keep in stock such cleaning and other supplies as may from time to time be required to carry out the obligations of the Manager under this Agreement; and
- (r) indemnify and save the Owner harmless from any claim, damage and cost incurred by the Owner as a result of any negligence, willful misconduct or breach by the Manager of a term of this Agreement.

5.2. **Annual Interior Deep Cleaning.** Subject to Section 5.3, the Manager will arrange for an interior deep cleaning of the Unit once in each calendar year (the "Annual Interior Deep Cleaning"), which will include the services described in Schedule D of this Agreement. In consideration for this service, the Owner will pay to the Manager the Owner's Annual Interior Deep Cleaning Charge in the amount applicable for the Unit as set by the Manager from time to time, which will be deducted by the Manager from the Owner's Net Rental Revenue. The

Manager may change the amount payable for any or all of the services set out in Schedule D once per calendar year at the start of the Winter Season upon 60 days written notice to the Owner. The Owner shall have the right to occupy the Unit during the Annual Interior Deep Cleaning, which shall be a minimum of 7 days annually.

- 5.3. The Manager reserves the right to arrange for an interior deep cleaning of the Unit twice in a calendar year if the average annual occupancy of the Unit exceeds 60% and the Manager determines in its sole discretion that an additional interior deep cleaning of the Unit is necessary given such occupancy levels, in which case the Owner will pay to the Manager an additional Owner's Annual Interior Deep Cleaning Charge in the amount applicable for the Unit as determined by the Manager from time to time.
- 5.4. **Annual Routine Maintenance.** Subject to Section 5.5, the Manager will arrange for a routine maintenance check of the Unit once in each calendar year. In consideration for this service, the Owner will pay to the Manager an Owner's Annual Routine Maintenance Charge in the amount applicable for the Unit as determined by the Manager from time to time, which will be deducted by the Manager from the Owner's Net Rental Revenue. The Manager may change the amount payable for any or all of the services set out in Schedule D once per calendar year at the start of the Winter Season upon 60 days written notice to the Owner.
- 5.5. The Manager reserves the right to arrange for routine maintenance of the Unit in accordance with Schedule D twice in a calendar year if the average annual occupancy of the Unit exceeds 60% and the Manager determines in its sole discretion that additional routine maintenance of the Unit is necessary given such occupancy levels, in which case the Owner will pay to the Manager an additional Owner's Annual Routine Maintenance Charge in respect thereof in the amount applicable for the Unit determined by the Manager from time to time.
- 5.6. **Damage to Unit.** The Manager will notify the Owner promptly of any material damage to the Unit. If the Manager deems, in its sole reasonable discretion, the Unit to be unfit for rental for any reason whatsoever at any time during the Rental Period, the Manager will notify the Owner of such condition and take such steps, as directed in writing by the Owner, as are reasonably necessary to remedy such condition, provided that such steps will be taken at the sole cost and expense of the Owner and the Manager will not be obligated to advance or utilize any of its own funds, including the Management Fee or any other amount owing to the Manager pursuant to this Agreement. Notwithstanding the above, the Manager will be responsible and will pay for the repair of any damage (other than that due to normal wear and tear) to the Unit or the contents of the Unit, including any thefts that are not covered by insurance policies held by the Manager, caused by any renter of the Unit pursuant to this Agreement, by any guest of any renter of the Unit, or by any employee or agent of the Manager. The Manager will pay the insurance deductible when a theft of property of the Owner occurs when either a guest is occupying the Unit or there is no sign of forced entry to the Unit.
- 5.7. **Repairs.** The Owner shall be responsible for all maintenance and repairs of the Unit and contents within the Unit except as otherwise specifically provided for in this Agreement, including without limitation, any structural repair or painting of the Unit. The Owner authorizes the Manager to make or cause to be made at the sole cost and expense of the Owner any minor repairs, including any item requiring attention due to normal wear and tear, provided that the cost of any single repair does not exceed \$300.00 CAD and that the total cost of such repairs does not exceed \$1,000.00 CAD in a calendar year, and any emergency repairs to the Unit or the contents within the Unit as the Manager may determine are necessary, and to deduct the cost of such repairs from the Owner's Net Rental Revenue. The Owner will reimburse the Manager in respect of any amount incurred in connection with such

repairs that is not deducted from the Owner's Net Rental Revenue forthwith upon receipt by the Owner of the Manager's invoice. Under no circumstances will the Manager be obligated to make or cause to be made any repairs to the Unit or the contents within the Unit except as set out in this Section 5.7. In the event of an emergency or disaster, the Owner authorizes the Manager to provide or contract for services necessary to mitigate additional damage, provided that the Manager provides the Owner with an estimate or estimates of such repair costs. The Owner acknowledges and agrees that the Manager will be entitled to a handling charge for management of the repair effort in the case of repairs necessitated by an emergency or disaster.

5.8. **Painting.** The Owner authorizes the Manager to paint or cause to be painted the Unit when required due to normal wear and tear, but no more frequently than once every three years, and to deduct the cost of such painting from the Owner's Net Rental Revenue. The Owner will reimburse the Manager in respect of any amount incurred in connection with such painting that is not deducted from the Owner's Net Rental Revenue forthwith upon receipt by the Owner of the Manager's invoice.

5.9. **Complimentary Use of Unit. *Intentionally Deleted.***

6. **OWNER'S OBLIGATIONS**

6.1. **Owner's Responsibilities.** The Owner will:

- (a) provide the Manager with keys for the Unit, any parking facility or storage areas applicable to the Unit, the entrance to the building in which the Unit is located (as applicable) and any other locked facility in the Unit to which the renters of the Unit will be permitted access (as applicable), and the Owner authorizes the Manager to duplicate any such keys as required by the Manager;
- (b) ensure that the Manager, the Manager's agents and representatives and the renters of the Unit have full, free and uninterrupted access to the Unit and any parking facility or storage areas applicable to the Unit as contemplated by this Agreement;
- (c) promptly pay when due all amounts owing under any financing of the Unit arranged by the Owner and all real property taxes, telephone and utility charges (provided that the Owner will not be responsible to pay for long distance telephone charges incurred by the renters of the Unit), cablevision charges, monthly maintenance fees, strata fees, if applicable, and all other fees, charges, taxes, rates, levies and assessments in respect of or relating to the Unit, provided that if the Owner fails to do so the Manager is irrevocably authorized (but not obligated) to deduct any such amounts from the Owner's Net Rental Revenue and pay it to the applicable party;
- (d) not permit any lien, charge or encumbrance to be filed against title to the Unit without the Manager's prior written consent, except in connection with the Owner's financing of the Unit;
- (e) ensure that the Unit is serviced with water, sewer, electricity, propane and internet access at all times during the Term;
- (f) take out and maintain at all times during the Term the following insurance pertaining to the Unit:
 - (i) comprehensive public liability insurance in the amount of at least \$2,000,000 for claims for personal injury, death or property damage arising out of any single occurrence;
 - (ii) rental interruption insurance with such policy limit as may be required by the Manager from time to time;

- (iii) contents insurance with respect to the Owner's property within the Unit; and
 - (iv) such other insurance as may be reasonably required by the Manager from time to time;
 - (g) during any period that the Unit is being rented pursuant to this Agreement, remove from the Unit or store within the Unit in a locked container or storage area all of the Owner's personal items and effects;
 - (h) indemnify and save the Manager harmless from any claim, damage and cost incurred by the Manager in connection with the management of the Unit and to carry at the expense of the Owner, adequate insurance to protect the Manager against any such claim, damage and cost in the same manner and to the same extent as the Owner naming the Manager as one of the insured; and
 - (i) comply with the Resort Policies, as may be amended from time to time, including without limitation regarding smoking and pets within the Unit.
- 6.2. **LIMITATION OF LIABILITY.** THE OWNER WILL NOT CHARGE THE MANAGER OR HOLD IT RESPONSIBLE FOR ANY LIABILITY FOR ANY ERROR OF JUDGMENT FOR ANY MISTAKE OF FACT OR LAW OR FOR ANYTHING WHICH IT MAY DO OR REFRAIN FROM DOING IN CONNECTION WITH THIS AGREEMENT EXCEPT IN THE CASE OF NEGLIGENCE OR WILFUL MISCONDUCT.
- 6.3. **Furniture, Fixtures and Equipment.** The Owner will furnish, maintain and equip the Unit and keep it furnished, maintained and equipped as a high-quality rental unit to a standard befitting the development the Unit is located within the Resort and comparable to that maintained in other Units within such development. Subject to approval of the Manager, which approval shall not be unreasonably withheld, the Owner may decorate the Unit to the Owner's personal taste provided however that linens and cutlery may be required to be purchased from the Manager. Without limiting the generality of the foregoing, the Owner will be solely responsible for the cost of repairing, maintaining or replacing any item of furniture, fixtures, equipment and supplies listed in Schedule E of this Agreement as necessary to maintain the Unit in a first-class, occupiable condition to the satisfaction of the Manager. The Owner will also be solely responsible for all repair, maintenance, restoration, redecorating and other expenses arising as the result of the rental or use of the Unit including normal wear and tear. For the purposes of this Agreement, "normal wear and tear" costs will include upkeep and maintenance expenditures necessitated due to the use of the Unit for short term vacation use in the manner contemplated in this Agreement, the Owner acknowledging that "normal wear and tear" upkeep and maintenance expenditures resulting from such rental occupancy of the Unit will exceed the "normal wear and tear" upkeep and maintenance expenditures which would be incurred by the Owner if the Unit was utilized solely for residential purposes or the Owner's personal use.
- 6.4. **Owner's Authorizations.** The Owner authorizes the Manager to take any and all such steps as are reasonably necessary or desirable to enable the Manager to perform efficiently its functions and duties under this Agreement including, without limitation, depositing and withdrawing funds from the Rental Operating Account as set out in this Agreement and performing the Manager's obligations set out in Section 5, and the Owner appoints the Manager to be the attorney of the Owner to execute all necessary instruments and documents of whatsoever kind or nature and to take or cause to be taken all such steps, actions or proceedings, in the name of and on behalf of the Owner, as fully and effectually in every respect as the Owner itself could do in respect of the matters herein contained, including the right to institute or defend legal proceedings in respect of the same, in relation to which the Owner hereby covenants and agrees to provide the Manager with all documents

and instruments of whatsoever nature reasonably required by the Manager and to cooperate with the Manager in instituting or defending legal proceedings as aforesaid, provided that the Manager will not be obligated to institute or defend any such legal proceedings and that such legal proceedings will be undertaken at the sole cost and expense of the Owner. The authority of the Manager to litigate on behalf of the Owner is restricted to collecting revenues. All other related matters require the Owner's consent.

6.5. **Sale of the Unit.** The Owner and the Manager agree as follows:

- (a) in the event the Owner wishes to sell, lease or otherwise directly or indirectly dispose of the Unit, the Owner will notify the Manager in writing forthwith prior to selling, leasing or otherwise disposing of the Unit;
- (b) the Owner will forthwith notify any proposed purchaser or lessee of the Unit of:
 - (i) the fact that the ownership and use of the Unit is subject to the rights of renters pursuant to this Agreement and the Rental Covenant; and
 - (ii) their right to obtain Financial Information from the Manager before an agreement of purchase and sale is entered into;
- (c) the Owner will not directly or indirectly sell, lease or otherwise dispose of the Unit unless prior to the completion of such transaction, the proposed purchaser or lessee:
 - (i) covenants in writing to the Manager and any other person the Manager may determine in a form reasonably required by the Manager, to be bound by the rental bookings of the Unit made by the Manager pursuant to this Agreement, and that the Manager will be entitled to receive the Management Fee and any other amount owing under this Agreement in respect of all future rental bookings of the Unit in existence as of the date of the completion of such transaction; and
 - (ii) if such purchaser or lessee wishes to rent the Unit, enters into a new rental management agreement with the Manager on the same terms and conditions as this Agreement, such new agreement to take effect as of the date of completion of such transaction;
- (d) the Owner and the proposed purchaser or lessee may jointly in writing direct the Manager not to make any further rental bookings of the Unit pursuant to this Agreement;
- (e) the Manager will, upon receipt of reasonable notice of an intended sale or lease of the Unit, deliver Financial Information to any prospective purchaser or lessee of the Unit before the agreement of purchase and sale is entered into;
- (f) the Manager will provide any prospective purchaser or lessee of the Unit with details in respect of the rental bookings of the Unit pursuant to this Agreement upon the written request of the Owner;
- (g) the Manager will not be required to make any adjustments as between the Owner and any purchaser or lessee of the Unit, and the Manager will be deemed to have fully discharged its obligations under this Agreement if the Manager pays the Owner's Net Rental Revenue for the month in which the sale of the Unit completes to or to the order of the person who was, according to the records of the Manager, the registered owner of the Unit on the first day of that month;
- (h) this Agreement will be deemed to be terminated after the completion of the sale, lease or other disposition of the Unit and the full satisfaction by the parties of their obligations under this Agreement; and

- (i) if any lease between the Owner and a lessee is terminated, the Owner will promptly notify the Manager and enter into a new rental management agreement with the Manager on the same terms and conditions as this Agreement.

7. **USE OF UNIT BY OWNER**

- 7.1. **Booking by Owner.** If at any time during the Rental Period, the Owner wishes to use the Unit for the Owner's Usage, the Owner will notify the Manager of the days the Owner wishes to use the Unit at least six (6) months prior to the commencement of each Season in which the Owner wishes to use the Unit, and the Owner will be entitled to use the Unit on such days. The Owner will otherwise be bound by the rental bookings of the Unit made by the Manager pursuant to this Agreement. The Owner will not be required to pay any rent, fees or surcharges for the days of the Owner's Usage except for the Owner's Departure Cleaning Charge described in Section 7.3. The Manager will provide the Owner with an Owner's Usage calendar prior to each Season which the Owner will be required to complete and return in order to book the Unit for the Owner's Usage.
- 7.2. **Change in Use.** The Owner will promptly notify the Manager in writing if the Owner determines or discovers at any time that the Owner will not use the Unit on any of the dates for which the Owner gave notice pursuant to Section 7.1 and the Manager may then rent out the Unit on such dates. If the Owner wishes to use the Unit on a date or dates for which the Owner has not given notice pursuant to Section 7.1, the Owner may make written application to the Manager, not more than 7 days in advance, requesting the use of the Unit. The Manager shall, subject to any rental bookings of the Unit, permit the Owner to use the Unit on such dates under the terms set out in Section 7.1.
- 7.3. **Owner's Departure Cleaning Charge.** At the end of a period of the Owner's Usage (including a single day stay) or Personal Use, where the Owner elects to commence a Rental Period, the Owner will pay the Manager a departure cleaning fee in the amount applicable for the Unit as determined by the Manager from time to time (the "Owner's Departure Cleaning Charge"). The Manager may change the amount of the Owner's Departure Cleaning Charge once per calendar year at the start of the Winter Season upon 60 days' written notice to the Owner. The Manager may deduct the applicable Owner's Departure Cleaning Charge from the Owner's Net Rental Revenue. If the Owner requests the Manager to provide special housekeeping services during the Owner's Usage or period of Personal Use (over and above departure cleaning services), the Owner will pay the Manager the applicable fee set by the Manager from time to time in addition to the Owner's Departure Cleaning Charge.
- 7.4. The Owner acknowledges and agrees that if extra cleaning of the Unit over and above the departure cleaning services set out in Schedule D is required, as determined solely by the Manager, at the end of the Owner's Usage (including a single day stay) or Personal Use, where the Owner has elected to commence a Rental Period, as a result of the Owner keeping a pet within the Unit during such period, the Owner will pay the Manager a fee of \$75.00 in addition to the applicable Owner's Departure Cleaning Charge.
- 7.5. **Vacating Unit.** The Owner will leave the Unit in a reasonably neat and tidy condition following the Owner's Usage or Personal Use. The Owner will vacate the Unit by 12:00 noon on the day following the last evening of the Owner's Usage or Personal Use, where the Owner has elected to commence a Rental Period.
- 7.6. **Use by Owner.** Any Owner's Usage of the Unit under this Section 7 will be strictly for the private purposes of the Owner or the Owner's non-paying guests, who will be subject to all the rights and obligations of the Owner under this Section 7. Under no circumstances will the Owner during the Term directly or indirectly charge rent or accept any form of consideration for the use of the Unit except in accordance with the Rental Covenant and this Agreement.

- 7.7. **Parking.** Subject to any applicable registrations or bylaws, the Manager will have the absolute right to control, manage and administer in connection with this Agreement any right to or interest in any parking stall or stalls at the Resort appurtenant to the Unit, provided that:
- (a) at any time the Manager will not utilize more parking stalls than the number of parking stalls which is equal to the number of Units that are being rented by the Manager under a rental management agreement; and
 - (b) subject to availability, the Owner will have the right to use one parking stall, free of charge, during a period of Owner's Usage or Personal Use reserved in accordance with this Section 7, as well as any other parking stall or stalls as may be allocated for the Owner's use by the Manager upon the request of the Owner, subject to availability and in the Manager's sole discretion.
8. **GENERAL**
- 8.1. **Schedules.** The Schedules are attached to and form an integral part of this Agreement.
- 8.2. **Time.** Time is of the essence of this Agreement.
- 8.3. **Cooperation.** The parties will at all times during the Term act in good faith, cooperate and act reasonably in respect of all matters within the scope of this Agreement.
- 8.4. **Approval by the Owner.** Whenever any matter pursuant to or arising out of this Agreement is left to the discretion or approval or disapproval of the Owner, the Owner will notify the Manager of his or her decision promptly. In the absence of a notification from the Owner within seven (7) days after notice has been given to the Owner by the Manager, the Manager will be entitled (but not obligated) to make such decision on behalf of the Owner. The Manager will not be responsible for any decisions so made or for the failure of the Manager to make any such decision provided that the Manager has acted in good faith.
- 8.5. **Dispute Resolution.** All disputes arising out of or in connection with this Agreement that the parties are unable to resolve informally within thirty (30) days may be referred to mediation on notice by one party to the other, with the assistance of a neutral mediator jointly selected by the parties. Failing agreement, the dispute shall be submitted to arbitration in the City of Revelstoke, British Columbia or any other venue agreed upon by the parties, pursuant to the Arbitration Act (British Columbia), as amended from time to time ("Arbitration Act") or by any other form of arbitration mutually acceptable to the parties. Unless the parties otherwise agree, such dispute, controversy or claim shall be determined by a single arbitrator. If the parties cannot agree on the arbitrator, the arbitrator shall be appointed further to the provisions of the Arbitration Act. Any award or order rendered by the arbitrator shall be final, conclusive and binding upon the parties and judgment may be entered on the arbitrator's award or order in any court having jurisdiction. The expenses of such mediation or arbitration shall be borne equally by the parties, except that each party shall be entirely responsible for its own legal fees and its nominee expenses, regardless of the outcome of the mediation or arbitration.
- 8.6. **Relationship.** This Agreement is not a lease, partnership or joint venture agreement and nothing contained in this Agreement will constitute the parties as landlord and tenant, partners or jointventurers.
- 8.7. **Notices.** Any payment, demand, notice, direction, consent, waiver or other communication required or permitted to be given or made under this Agreement will be in writing and will be effectively given and made if (i) delivered personally, (ii) sent by prepaid courier or mail to the party's address set out on the first page of this Agreement, or at such other address as either party may specify in writing, or (iii) sent by e-mail or other similar electronic means of

electronic communication. Notice will be deemed given when received or, if delivery is refused by the party to which it is intended to be given, on the date delivery is so refused.

- 8.8. **No Waiver.** No failure or delay on the part of either party in exercising any right, power or privilege under this Agreement will operate as a waiver, nor will any single or partial exercise of any right, power or privilege preclude any other or further exercise of any other right, power or privilege.
- 8.9. **Governing Law.** This Agreement will be governed by and construed according to the laws of the Province of British Columbia and the federal laws of Canada as applicable.
- 8.10. **Canadian Funds.** All amounts payable by either party to the other will be paid in Canadian funds.
- 8.11. **Entire Agreement.** This Agreement, including any schedules and any documents incorporated by reference, constitute the entire Agreement between the parties and supersedes all previous negotiations, proposals, commitments, writings and understandings of any nature, whether oral or written, unless they are expressly incorporated by additional reference in this Agreement.
- 8.12. **Amendment.** No amendment, change or modification of this Agreement is valid unless it is in writing and signed by both parties.
- 8.13. **Assignment.** This Agreement is not assignable by the Owner, whether by operation of law, assignment, transfer or otherwise, without the prior written consent of the Manager and the assignee's agreement to be bound by the terms of this Agreement. The Manager may assign this Agreement in accordance with Section 2.12.
- 8.14. **Gender and Number.** Words importing the masculine gender include the feminine or neuter gender and words in the singular include the plural, and *viceversa*.
- 8.15. **Joint and Several.** If the Owner is more than one person, all of the covenants and liabilities of the Owner are joint and several.
- 8.16. **Enurement.** This Agreement will enure to the benefit of and be binding upon the heirs, executors, legal representatives, successors and permitted assigns of the parties.
- 8.17. **Survival.** The following provisions survive the termination or expiry of this Agreement and continue in full force and effect, and do not merge: Sections 2.5, 2.11(c), 5.1(r), 6.1(h) and 6.2.
- 8.18. **Severability.** If any provision of this Agreement is determined to be invalid or unenforceable, in whole or in part, by a court of competent jurisdiction, such invalidity or unenforceability attaches only to such provision and everything else in this Agreement continues in full force and effect.
- 8.19. **Counterparts.** This Agreement may be executed electronically and in counterparts, all of which taken together will be deemed an original and constitute one Agreement, and may be delivered electronically.

Intentionally left blank
See next page for signatures

IN WITNESS WHEREOF the parties have executed this Agreement as of the date first above written.

BY THE MANAGER:

REVELSTOKE ALPINE VILLAGE INC.

by its authorized signatory(ies):

Name:

BY THE OWNER:

[If Individual(s)]

Name:

Name:

[If Company]

by its authorized signatory(ies):

Name:

Name:

SCHEDULE A

OWNER'S ELECTION TO RENT

I, _____, Owner of _____
_____ [legal description] hereby elect to make
the Unit available for rent to the Public, pursuant to Section 2.3 of the Rental Management
Agreement.

The commencement date of the Rental Period shall be _____.

Dated the _____ day of _____, 20__.

[If Individual]

Owner Signature: _____

Owner Signature: _____

[If Company]

by its authorized signatory(ies):

Name:

Name:

SCHEDULE B

	<u>Manager</u>	<u>Owner</u>
Advertising & promotion	X	
Bank charges	X	
Booking commission ⁽¹⁾	50%	50%
Brochure	X	
Business Licence	X	
Cable/Smart TV		X
Cleaning supplies	X	
Clerical & accounting	X	
Computer costs	X	
Credit Card Commission ⁽¹⁾	50%	50%
Front desk & reservations staff Fill	X	
Appliance replacement		X
Guest supplies	X	
Insurance – contents, rental interruption		X
Insurance – liability	X	X
Kitchen utensils and dishware	X	
Laundry	X	
Linen and bedding supply		X
Linen replacement	X	
Manager’s telephone reservation line	X	
Normal wear and tear		X
Office equipment	X	
Owner’s Annual Interior Deep Cleaning Charge ⁽²⁾		X
Owner’s Departure Cleaning Charge ⁽²⁾		X
Owner’s monthly statements	X	
Owner’s Annual Routine Maintenance Charge ⁽²⁾		X
Photocopying	X	
Property taxes		X
Renter damage	X	
Reservation System/Affiliation fee (if applicable) ⁽¹⁾	50%	50%
Stationary & office supplies, postage	X	
Strata fees		X
Utilities		X

⁽¹⁾ Deducted from Gross Revenue

⁽²⁾ Deducted from Owner’s Net Rental Revenue

SCHEDULE C

Revelstoke Mountain Resort Pricing Management General Guidelines

In order to achieve the highest occupancy percentages and average daily rates, a variety of pricing options are available to transient, wholesale, travel agents, tour operators, corporate and leisure travel groups and other guests. The Manager will use its best judgement in an effort to secure consistent levels of occupancy. The following typical forms of lodging or hotel rates and packages are offered

RACK RATES

“Rack Rate” is a lodging and hotel industry term meaning “full price lodging”. Rental guests not on a package or other special rates will be on Rack Rate. In addition, the Manager may elect not to offer packages if it feels Rack Rates can prevail

PACKAGE RATES

Through a package a rental guest has the opportunity to enjoy the lodge and resort without having to worry about purchasing the individual components (including, but not limited to, ski tickets, ski school, golf, adventure packages, childcare, meals. etc.). A package's components are all discounted so that the rental guest will receive value through the purchase that could not have been obtained through separate purchases, including lodging. The Manager recognizes the importance of, and will actively promote, packages to encourage rental guest satisfaction, encourage length of stay (especially midweek) and build overall business resulting in both a short-term and long-term benefit to the Owner.

WHOLESALE / TOUR OPERATOR / TRAVEL AGENTS

One of the best ways to drive occupancy is to have a large distribution network of people selling your property. This gets the information about the lodging and Revelstoke Mountain Resort out to many more people than the Manager could do on its own. In effect, the Manager has sales people all over the world working to fill its beds. The Manager recognizes this and therefore has established "net" rates for the business and people that work in the wholesale, tour operator and travel agent industries. The wholesaler or tour operator that sends the Manager the most business is rewarded with the “best” rates. These types of businesses are the largest source of destination extended stay bookings and therefore are critical in driving occupancy.

GROUP RATES

Group business is recognized by the Manager to be an important way to build occupancy, “rounding it out” throughout the year, especially during quieter periods. The Manager will encourage corporate and leisure group business in its effort to build consistent occupancy among all units. All group rates are negotiated separately by the sales team in a manner that will optimize current and future sales. Offered rates take into consideration length of stay, time of year and size of group.

SPECIAL RATES

The Owner must recognize that a key focus of the Manager is to promote a favorable guest experience that will encourage rental guests to return. The Manager has no desire to arbitrarily forego rental revenues, but understands that a satisfied rental guest is crucial to the ongoing success and future of renting the Owner's Unit. If the Manager determines it necessary or advisable to provide special rates, it will do so appropriately with an eye towards gaining the satisfaction of the rental guest, encouraging length of stay and creating a desire to return, thus enhancing the Owner's long-

term goals.

HOLIDAY RATES

The Manager may establish holiday rates, which may exceed regular Rack Rates during certain holiday or special event periods: however, other rates may also be available during such periods, such as group, reduced or special rates.

SCHEDULE D

Housekeeping and Maintenance Services Housekeeping Services

A. Departure Cleaning

Departure cleaning services will include the following:

Kitchen	Clean all appliances, wipe all cabinets and cupboards, clean baseboards, scrub and clean floors, remove all left-over food stuffs.
Dining Room	Clean light fixtures, wipe baseboards.
Living Room	Clean windows, lamps, remove chair cushions and sofa cushions and clean, make up sofa bed, clean window blinds.
Bathrooms	Clean walls and both sides of the door, wipe inside vanity drawers and underneath cabinet, clean baseboards and scrub floor.
Bedrooms	Clean and vacuum behind and under furniture, wipe out all drawers, wipe baseboards, clean windows, sills, blinds and tracks.
General	Check for damage, check inventory levels, maintenance items, sweep cobwebs, neaten and straighten all furniture and decorative items, and collect personal items left behind.
Decks (if applicable)	Furniture wiped, deck swept/shoveled and outside windows within reach cleaned.

B. Annual Interior Deep Cleaning

Annual interior deep cleaning services will include the following:

Kitchen	Remove all vents and clean, wash painted walls, wash inside and outside all cabinets and drawers, pull out appliances and clean behind and all surfaces, remove light fixtures and clean, dust walls top to bottom.
Dining Room	Clean vents, move all furniture and vacuum, wash walls.
Living Room	Move all furniture and vacuum, wash walls, check propane fireplace, and wash windows.
Bathrooms	Remove vents and clean, clean ceiling and light fixtures.
Bedrooms	Clean light fixtures and vents, move beds and furniture and vacuum, clean all doors on both sides, wash walls.
General	Steam clean entire carpeted area, identify and have repaired any maintenance deficiencies, check all plugs and outlets, wash all windows inside and out.

SCHEDULE E

Furniture, Fixtures and Equipment Owner Responsibilities

As set out in Section 6.3 of the Agreement to which this Schedule E is attached, and without limiting the generality of Section 6.3 or any other provisions of the Agreement, the Owner will be solely responsible for the cost of repairing, maintaining and replacing the furniture, fixtures, equipment and other items listed below, necessary to maintain the Unit in an occupiable first-class condition:

- ☐ Carpet
- ☐ All furniture in all rooms
- ☐ Sofa bed(s)
- ☐ Beds
- ☐ All appliances
- ☐ Tile and/or linoleum
- ☐ TV's
- ☐ Coffee maker
- ☐ Kettle
- ☐ Toaster
- ☐ Blender
- ☐ iron and ironing board
- ☐ Clock radio
- ☐ Telephones
- ☐ DVD
- ☐ Hair dryer
- ☐ All decor items/wall hangings
- ☐ Duvet and duvet covers

For information purposes and to allow the Owner time to budget for these expenses, please note the estimated expected "life" of the major items identified below which will be the sole responsibility of the Owner:

- ☐ Carpet - replace every 5 - 7 years
- ☐ Painting - total repaint every 3 years or as needed due to "normal wear and tear"
- ☐ Furniture - replace every 4 - 8 years, depending on condition and quality
- ☐ Sofa bed(s) - replace mattress and mechanism as needed (3 - 5 years)
- ☐ Decor / wall hangings - every 6 years or as needed
- ☐ Beds - replace mattresses every 4 years
- ☐ Major appliances - replace every 6 -10 years or as needed
- ☐ Tile and / or linoleum - replace every 5 - 7 years
- ☐ TV's - replace every 5 -10 years or as needed

Schedule "I"
Common Lot Covenant

TERMS OF INSTRUMENT – PART 2

WHEREAS:

- A. “Common Lot” means Lot 1, Section 23, Township 23, Range 2 West of the 6th Meridian, Kootenay District, as shown on Plan of Subdivision registered under number EPP _____;
- B. “Lands” means collectively the land described in Form C – Part 1, Item 2 hereto;
- C. “Transferors” means the parties described in Form C – Part 1, Item 5 hereto;
- D. “Transferee” means the party described in Form C – Part 1, Item 6 hereto;
- E. Section 219 of the Land Title Act, R.S.B.C., 1996 c. 250, provides that a covenant, in favour of the Transferee, whether of a negative or positive nature, in respect of the use of the Lands or that the Lands are or are not to be built on, may be registered as a charge against the title to the Lands and is enforceable against the Transferor and its successors in title even if the covenant is not annexed to land owned by the Transferee;
- F. The Transferee has been designated under section 219(3)(c) of the *Land Title Act*, evidence of which designation has been filed in the Kamloops / Nelson Land Title Office under instrument number LB090393;
- G. The Transferors have agreed to enter into this Covenant with the Transferee in accordance with section 219 of the *Land Title Act* to establish the condition that the Common Lot may only be used for utility, access and visitor parking purposes and to set out the requirements the Transferors must comply with to permit use of and access to the Common Lot; and
- H. The Transferors attest that the Lands encumbered by this Agreement do not lie within an Agricultural Land Reserve.

Now therefore in consideration of the promises set forth in this Covenant and other good and valuable consideration, the receipt and sufficiency of which is hereby acknowledged, the parties hereby agree as follows:

- 1. Hereafter the Common Lot shall not be used for any purpose other than as a utility corridor, private access road, and visitor parking.
- 2. The Transferors covenant and agree that the Common Lot will only be used in accordance with and on the terms and conditions set out in this Agreement.
- 3. The Transferors covenant and agree that the Transferors shall only use the Common Lot on the following terms:
 - a) to maintain the Common Lot in such a condition as to satisfy the purposes defined in the paragraph 1 of this Agreement;
 - b) all decisions regarding the maintenance, including snow removal, repair and replacement of the Common Lot for access purposes will be agreed upon by a majority vote of the Transferors;

- c) to contribute to the total costs of such maintenance, repair and replacement approved in accordance with paragraph 3(b) in proportion to their respective registered interest in the Common Lot;
- d) to take out and keep, or cause to be taken out and kept in force, the following insurance policies for the benefit of the Transferor:
 - i) insurance against fire and other risks of physical loss or damage covered by a standard all-risks policy, and insurance against all other hazards covered by policies normally in use from time to time by prudent owners of properties similar to the Common Lot for access purposes in an amount equal to the full replacement cost thereof; and
 - ii) comprehensive public liability insurance, including all risk normally insured by prudent owners in connection with the use and occupancy of properties similar to the Common Lot for access purposes, in respect of the use and occupancy thereof, for claims for personal injury, death, or property damage arising out of any one occurrence with limits that are prudent for owners of properties similar to the Common Lot for access purposes;
- e) to provide, within a reasonable time after request by the Transferee, a copy of the certificates evidencing such valid insurance required under paragraph 3(d);
- f) to indemnify and save harmless the other Transferors in respect of all actions, causes of action, suits, losses, expenses, costs and damages of any kind or nature whatsoever suffered by the other Transferors, arising out of or in any way related to the exercise of the Transferors of its rights including any injury or death to any person or any damage to or loss of property, except to the extent any of the foregoing is caused by the negligence or wilful misconduct of any of the other Transferors, or any of them or any person for whose conduct any of the other Transferors are responsible for in law;
- g) to not create or permit to remain and shall remove and discharge or cause to be removed and discharged promptly, any lien, encumbrance or charge on the Common Lot which arises out of the exercise of its rights or observance or performance of any of its obligations under this Agreement, at the cost and expense of the Transferor whose exercise of rights, observance or performance resulted in the lien, encumbrance, or charge;
- h) that if any Transferor uses the Common Lot so as to cause damage to the Common Lot then the responsibility of the repair of the damage is that of the Transferor that caused it;
- i) that a Transferor may, from time to time, temporarily interrupt the use and enjoyment of the whole or any part of the Common Lot for the purposes of maintenance, repair or replacement provided the interruption is of as short a duration as reasonably possible and the Transferor provides 48 hours written notice (except in the case of a bona fide emergency when no notice shall be required) to the other Transferors;
- j) that if required by a municipal, provincial or federal government or any other authority (including public utilities) (the "Authority"), the Transferors will grant statutory rights of way, covenants, easements or any other encumbrances in favour of such Authority over the whole or any part of the Common Lot provided the encumbrance is not inconsistent with the provisions of this Agreement;
- k) the cost-sharing arrangements shall enure to the benefit of and be binding upon the parties hereto and their respective heirs, executors, administrators, successors and assigns;

- l) If the parties to this Agreement do not agree on any matter contemplated under this Agreement, any such disagreement will be referred to a single arbitrator for arbitration under the *Arbitration Act*, R.S.B.C. 1996, c. 55, as amended from time to time (the “Act”). The single arbitrator will be appointed by agreement between the parties within 15 days (or such extended time as the parties may agree on) of any party notifying the others in writing of a disagreement, failing which the arbitrator will be appointed in the manner provided under the Act. The costs of the arbitrator and the award will be in the discretion of the arbitrator, who may direct to whom and by whom and in what manner those costs or any part thereof will be paid, and may tax or settle the amount of costs to be paid or any part thereof and may be final and binding on the parties.
4. The Transferors agree to ensure that all authorities having jurisdiction have unrestricted access over, across and through the Common Lot for the purposes of firefighting, suppression, control and prevention.
5. Pursuant to Section 219 of the *Land Title Act*, the covenants herein contained shall be covenants running with the Lands and shall enure to the benefit of and be binding upon the Transferor and the Transferor’s heirs, executors, administrators, successors, assigns and successors in title.
6. A Transferor is only liable for breaches of this Agreement that occur while the Transferor is a registered owner of the Common Lot.
7. In this Agreement unless the context otherwise requires, the singular includes the plural and vice versa.
8. This Agreement will be interpreted according to the laws of the Province of British Columbia.
9. If any part of this Agreement is found to be illegal or unenforceable, that part will be considered separate and severable and the remaining parts will not be affected thereby and will be enforceable to the fullest extent permitted by law.
10. Nothing contained or implied in this Agreement shall prejudice or affect the exercise of any of the Transferee’s functions under any source of authority including, without limitation, any statutes, regulations, bylaws, orders or other constating documents, all of which may be fully and effectively exercised by the Transferee.
11. The Transferors will do or cause to be done all things and execute or cause to be executed all documents and give such further and other assurances which may be reasonably necessary to give proper effect to the intent of this Agreement.
12. This Agreement will not be modified or discharged except in accordance with the provisions of Section 219(9) of the *Land Title Act*.

IN WITNESS THEREOF the parties acknowledge that this Agreement has been duly executed and delivered by the parties executing Part 1 of Form C attached to and forming part of this Agreement.

Schedule "J"
Purchase Agreement

CONTRACT OF PURCHASE AND SALE

THE PURCHASER HEREBY OFFERS to purchase the Strata Lot for the Purchase Price on the terms and conditions contained in this Agreement.

“Seller” **Northland Properties Corporation**

“Purchaser”

Address: _____

Telephone: _____

E-mail: _____

Occupation or principal business: _____

Date of Birth (if individual): _____

Date of Birth (in individual): _____

Identification: _____

Residency:

Is the Purchaser a “non-resident” of Canada as defined under the *Income Tax Act* (Canada) YES NO.

Is the Purchaser a “non-Canadian” as defined under the *Prohibition on the Purchase of Residential Property by Non-Canadians Act* (Canada) YES NO.

Residency:

Is the Purchaser a “non-resident” of Canada as defined under the *Income Tax Act* (Canada) YES NO.

Is the Purchaser a “non-Canadian” as defined under the *Prohibition on the Purchase of Residential Property by Non-Canadians Act* (Canada) YES NO.

“Strata Lot”

Proposed strata lot _____, unit number _____, (the “Strata Lot”) to be constructed in a development known as “The Benchland Townhomes” (the “Development”) on lands presently legally described as PID: 010-884-165 The southeast quarter of Section 23, Township 23, Range 2 West of the 6th Meridian, Kootenay District except (1) Parcel A (Reference Plan 6926) and (2) parts included in Plans 8496, 14766, NEP19168, NEP19836 and NEP83496 and PID: 014-013-924 The north half of the southwest quarter of Section 23, Township 23, Range 2 West of the 6th Meridian, Kootenay District except (1) part included in Plan 11424, (2) Parcel 1 (reference plan 7168) and (3) Parcel A (reference Plan 48414) (the “North Half Property”), together with all furnishings, fixtures, and equipment relating thereto as more particularly described in the Disclosure Statement and as set out in any Addendum(s) hereto.



“Purchase Price” The Purchase Price for the Strata Lot is \$ _____, (plus any amount payable for upgrades and other extras). The Purchaser acknowledges and agrees that the Purchase Price is exclusive of applicable taxes, including, without limitation, property transfer taxes, Goods and Services Tax (“GST”) and any other federal or provincial sales, services value added, transition or other tax.

A “Initial Deposit” in the amount of \$ _____ (equal to 10% of the Purchase Price) shall be paid to the Seller (payable to the Seller’s solicitors, Pushor Mitchell LLP, in Trust) within 72 hours of acceptance of this Agreement by the Seller.

A “Second Deposit” in the amount of \$ _____ (equal to 10% of the Purchase Price) shall be paid to the Seller (payable to the Seller’s solicitors, Pushor Mitchell LLP, in Trust) within 30 days of the Purchaser receiving from the Seller an Amendment to the Disclosure Statement setting out building permit and construction financing particulars.

If a Consolidated Disclosure Statement or an Amendment to Disclosure Statement setting out building permit and construction financing particulars in respect of the Strata Lot has already been delivered to the Purchaser, then the Initial Deposit and Second Deposit shall be paid to the Seller (payable to the Seller’s solicitors, Pushor Mitchell LLP, in Trust) within 72 hours of acceptance of this Agreement by the Seller.

(the Initial Deposit and Second Deposit when paid, are collectively called the “Deposit”).

The balance of the Purchase Price, subject to closing adjustments, shall be paid by certified cheque or bank draft on the Completion Date.

“Furnishings” The Purchase Price includes the following equipment, appliances and furnishings:

- [a] window coverings
- [b] electric range
- [c] refrigerator
- [d] dishwasher
- [e] microwave
- [f] washer / dryer

“Completion Date” The Completion Date for the purchase and sale of the Strata Lot will be set out in paragraph 2 of Schedule A.

“Disclosure Statement” The Disclosure Statement is the document filed with the Superintendent of Real Estate as required by the *Real Estate Development Marketing Act* in relation to the Development.

“Purchaser’s Offer” The Purchaser hereby offers and, if this offer is accepted by the Seller, agrees to purchase from the Seller the Strata Lot and certain rights to the Strata Lot on the terms set out above and on Schedules A, B, and C hereto which forms part of this Agreement. The Purchaser’s Offer herein will be open for acceptance by the Seller on presentation until 11:59 p.m. on _____, 20____ and upon acceptance by the Seller signing a copy of this Agreement, there will be a binding agreement of sale



and purchase in respect to the Strata Lot for the Purchase Price, on the terms and subject to conditions set out herein.

The Purchaser's obligation to complete the purchase of the Strata Lot is subject to and conditional upon the following (collectively, the "Purchaser's Condition"):

provided that the foregoing conditions are for the sole benefit of the Purchaser and may be unilaterally waived in whole or in part by the Purchaser at any time before the date specified above, by the Purchaser giving notice to the Seller. In the event that the Purchaser's Condition is not satisfied or waived on or before the date specified, failing further agreement between the parties, the Deposit shall be returned to the Purchaser without deduction, and this Agreement will be null and void, and neither party shall have further obligations to the other.

Upon acceptance of this offer by the Seller, this Contract of Purchase and Sale including Schedules A, B, and C attached shall become a binding contract for the purchase and sale of the Strata Lot in accordance with its terms. The Seller and/or Purchaser may make this offer or accept it by executing in counterpart a facsimile copy of this offer and delivering it by facsimile or by any other means to the other party.

DATED: _____, 20____.

WITNESS:

Name:

PURCHASER: _____

Name:

PURCHASER: _____

Northland Properties Corporation. hereby accept the Purchaser's offer and agrees to sell the Strata Lot to the Purchaser in accordance with this Agreement this _____ day of _____, 20 _____.

Northland Properties Corporation
Per:

Authorized Signatory

_____|_____|_____

SCHEDULE A

ADDITIONAL TERMS AND CONDITIONS

1. DEPOSIT- The Deposit shall be paid by certified cheque, or bank draft or electronic funds transfer by the Purchaser, and shall be held as a stakeholder by the Seller’s Solicitor, in trust. The Deposit is non-refundable and is absolutely forfeited to the Seller without prejudice to the Seller’s other remedies if the sale and purchase contemplated by this Agreement is not completed by reason of the Purchaser’s default under this Agreement. Notwithstanding the foregoing, the Seller may wait to forward the Deposit to the Seller’s Solicitor until the seven (7) day rescission period pursuant to the *Real Estate Development Marketing Act* has passed and the Purchaser has not rescinded this Agreement by such time.

2. COMPLETION DATE –

(a) The Purchaser will pay the balance of the Purchase Price, as adjusted in accordance with this Contract by delivery to the Seller’s Solicitor of a solicitor’s certified trust cheque, a certified cheque or bank draft by no later than 2:00 p.m. on the Completion Date. The Completion Date will be a date established by the Seller and set out in a written notice (the “Completion Notice”) to the Purchaser or their solicitor (the date so established herein called the “Completion Date”) which shall be a minimum of 14 days after the date on which the Seller has delivered such notice to the Purchaser or their solicitor. The Completion Date shall be after the date that permission has been given to occupy the Strata Lot and title to the Strata Lot has been issued by the appropriate Land Title Office. The Seller presently anticipates that issuance of title by the Kamloops Land Title Office of the Strata Lot will be given on or about the ____ day of _____, 20____. For the purposes of this paragraph, permission to occupy the Strata Lot means the initial permission, whether such permission is temporary, conditional, or final and refers to occupation of the Strata Lot only and not to occupation of other strata lots or common property in the Development. If the Strata Lot is not ready to be occupied on the Completion Date so established by the Completion Notice, then the Seller may delay the Completion Date from time to time as required, by written notice of such delay to the Purchaser or the Purchaser’s solicitors (each, a “Completion Extension Notice”).

(b) The Completion Date will be no later than the ____ day of _____, 20____ (the “Outside Completion Date”), provided that if the Seller is delayed from transferring the Strata Lot because of any circumstance described in paragraph 2(c), the Seller may at any time on or before the Completion Date by written notice (the “Notice”) addressed to the Purchaser and delivered to the Purchaser, Purchasers Agent or Purchasers Solicitor by electronic means, including, without limitation, e-mail, extend the Outside Completion Date to such later date as may be specified in the Notice provided that if the Outside Completion Date must be extended for more than 6 months, then the Purchaser may, at their option (which option must be exercised within 5 days after receipt of the Notice), terminate this Agreement by giving written notice to such effect to the Seller. Upon such termination, the Deposit will be returned by the Seller to the Purchaser forthwith upon notice of termination and the Seller and the Purchaser shall thereafter have no further obligations to one another. Any references to the Completion Date will be a reference to the Completion Date as may be extended pursuant to this paragraph 2(b).

(c) If the Seller is delayed in transferring the Strata Lot or in doing anything the Seller is required to do pursuant to this Agreement and the delay is caused by any condition or cause beyond the reasonable control of the Seller including, without limitation, acts or omissions by third parties not related to the Seller, strike, lockout, labour dispute, epidemic, pandemic, outbreak, disease or other public health emergency, unusual geotechnical conditions, climatic conditions, acts of god, inability to obtain labour or material, laws, ordinances, rules, regulations or orders of governmental authorities, enemy or hostile action, civil commotion, fire or other casualty, the time

--	--	--

for transferring the Strata Lot or for the Seller doing anything the Seller is required to do pursuant to this Agreement may be extended by a time equivalent to the period of such delay.

3. **ADJUSTMENT DATE** – All adjustments relating to the purchase of the Strata Lot with respect to taxes, utilities and other items normally adjusted between a Seller and a Purchaser will be made on the Completion Date.
4. **PROPERTY TAXES** – The Purchaser hereby acknowledges and agrees that there may not be individual municipal property tax notices issued in respect of the Strata Lot prior to the Completion Date, and in such case the Purchaser covenants and agrees that municipal property taxes for the Lands will be adjusted on the basis of the unit entitlement of the Strata Lot as a percentage of the aggregate unit entitlements of all strata lots within the strata plan (the “Strata Plan”) of which the Strata Lot forms a part. If the Completion Date occurs prior to the date upon which municipal property taxes are due in respect of the Lands or Strata Lot, then notwithstanding that the Purchaser may not be entitled to an individual tax receipt in respect of the Strata Lot, the Purchaser shall pay the adjusted tax portion to the Seller, who hereby covenants and agrees to pay municipal property taxes for the current year in respect of the Lands and Strata Lot. Provided, however, that the Seller or Seller’s solicitor shall not be required to provide an undertaking with respect to payment of such taxes as a condition of completing the purchase and sale of the Strata Lot on the Completion Date.
5. **OCCUPANCY DATE** – Provided that the Seller’s solicitors have received the adjusted Purchase Price from the Purchaser in accordance with the terms of this Agreement, the Purchaser shall have occupancy of the Strata Lot after 12:00 p.m. on the day following the Completion Date. The Purchaser will be responsible for all utility charges as of the Occupancy Date and must ensure that they notify the necessary utility companies to have the utilities transferred into his/her/its name on the Occupancy Date. If the Purchaser does not transfer the utilities into the Purchaser’s name as of the Occupancy Date, then any charges to the Seller that should be the Purchaser’s responsibility will be paid to the Seller in full within 5 business days after notification thereof from the Seller. If such amount is not paid within such period, a charge of \$100.00 will be applied to the outstanding amount and a further \$100 will be applied thereafter for each additional month during which the amount remains outstanding.
6. **DEVELOPMENT** - The Seller will proceed to construct the development (the “Development”) as set out in the Disclosure Statement, provided that the Seller may make modifications as are desirable and reasonable.
7. **FINISHING** – The Seller will provide materials and labour to complete the interior finishing of the Strata Lot in reasonable conformity with the specifications set out in the Disclosure Statement. The Seller reserves the right to make minor variances or changes to the work, if in the Seller’s opinion such minor variations or changes are necessary. Any such variations or changes will be within the general scope and intent of the specifications and if materials are substituted those substituted will be equal or better quality, which is to be determined at the sole discretion of the Seller, and in all circumstances be fit for the purposes for which they are used. The Seller shall substantially complete the performance of the work in a good and workman like manner by the Completion Date.
8. **CONSTRUCTION** – The Purchaser acknowledges and agrees that area measurements are approximate and based on architectural drawings and measurements. Final floor plan and surveyed areas may vary. The Strata Lot is as shown on the sketch plan forming party of the Disclosure Statement. The Seller may make alterations to the features and layout of the Strata Lot which are desirable in the discretion of the Seller. The Seller reserves the right to alter the common property of the Development at any time and from time to time, if, in its sole discretion, such alteration or alterations improve the structural integrity of the Development, its mechanical systems, its ability to withstand water penetration or aesthetics. The proposed dimensions, lot lines and location of the strata lots in the Development are set out in the sketch plan. The actual size, dimensions, and/or configuration of the strata lots, balconies, patios, and/or decks and/or other limited common property as set forth in the final strata plan for the Development may vary

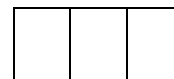

from what is depicted on the sketch plan. The areas and dimensions of the strata lots in the Development set out in the marketing materials are approximate and are provided for information purposes only and are not represented as being the actual final areas and dimensions of the strata lots (including the Strata Lot) in the Development. In the event of any discrepancy between the area, size, dimensions, location and or configuration of the strata lots, balconies, patios and/or decks and/or other limited common property in the sketch plan and/or any architectural plans relating to the Development and/or any marketing materials and the final strata plan, the final strata plan will prevail.

9. MINOR DISCREPANCIES – The Seller represents and warrants that the area of the Strata Lot will be no more than 5% smaller than indicated in the Disclosure Statement when measured in accordance with the *Strata Property Act* (British Columbia). If the area of the Strata Lot is more than 5% smaller, then the Purchase Price will be reduced by a percentage equal to the number of percent by which the area of the Strata Lot is more than 5% smaller.

10. INSPECTION – The Purchaser and a representative of the Seller shall inspect the Strata Lot at such reasonable time on or before the Completion Date as may be specified by the Seller in writing (the “Inspection Notice”). At the conclusion of such inspection, a list (the “List”) of any defects or deficiencies shall be prepared and signed by a representative of the Seller and the Purchaser. Upon the List being signed by the Seller and the Purchaser, the Purchaser shall be deemed to be satisfied with and to have accepted the physical condition of the Strata Lot, subject only to the correction of such defects or deficiencies by the Seller. If the Purchaser neglects to attend, or is absent from the inspection on the date as set out in the Inspection Notice, then it is understood that the Purchaser has forfeit its right to inspection of the Strata Lot prior to the Completion Date, and if so forfeited, the Purchaser will be deemed to be satisfied with and to have accepted the physical condition of the Strata Lot on the Completion Date. The Purchaser acknowledges and agrees that:
 - (a) while the Seller will endeavour to rectify the defects or deficiencies in the List prior to the Completion Date, the Seller does not guarantee that it will do so and the Seller may elect to rectify the deficiencies following the Completion Date within a reasonable period of time;
 - (b) the Seller and its representatives will have the right to enter the Strata Lot following the Completion Date during normal working hours, with reasonable notice, in order to carry out the work necessary to rectify the deficiencies;
 - (c) the manner in which the deficiencies are rectified will be determined by the Seller in its sole and absolute discretion;
 - (d) there will be no holdback from the Purchase Price in respect of the deficiencies; and
 - (e) the Purchaser will not be entitled to have access to the Development prior to the Occupancy Date except on the date or dates set by the Seller for inspection.

11. RISK – The Strata Lot will be at the Seller’s risk and shall be insured by it until 12:01 a.m. on the Completion Date, and thereafter shall be at the Purchaser’s risk.

12. BUILDER’S LIEN – The Seller acknowledges that there may be a builder’s lien holdback (the “Holdback”), as required by the *Strata Property Act* of British Columbia and *Builders Lien Act* of British Columbia or successor statutes. The Purchaser agrees the Holdback shall be paid to the Seller’s solicitor on the Completion Date and shall be held in trust for the Purchaser pursuant to the *Strata Property Act* of British Columbia and *Builders Lien Act* of British Columbia or successor statute solely in respect of any lien claims registered in the appropriate Land Title Office in connection with work done on the building comprising the Strata Lot.

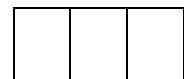

- 13. SELLER'S REPRESENTATIONS** – The Seller hereby represents and warrants that on the Completion Date, the Seller will cause good and marketable title to the Strata Lot to be transferred to the Purchaser, subject only to subsisting conditions, provisions, restrictions, expectations and reservations contained in the original grant or in any other grant or disposition from the Crown, except as set out in the Disclosure Statement (the subsisting conditions, provisions, restrictions, expectations and reservations contained in the original grant or in any other grant or disposition from the Crown and those encumbrances and charges set out in the Disclosure Statement are collectively referred to as the “Permitted Encumbrances”), and except for the Seller’s financial charges to be discharged by the Seller as provided in paragraph 16 of this Agreement.
- 14. WARRANTY** – Other than a written warranty effective from the date of occupancy to be issued by the Seller to the Purchaser by an approved warranty company pursuant to the provisions of the Homeowner Protection Act, it is agreed that there are no representations, warranties, guarantees, promises or agreements other than those contained herein, all of which shall survive the closing the within purchase and sale and shall not merge therewith.
- 15. CLOSING PROCEDURES** – The Purchaser’s solicitors will prepare and deliver to the Seller’s solicitors at least 5 (five) business days prior to the Completion Date, a Statement of Adjustments, and a Form A Freehold transfer (the “Transfer”) for the Strata Lot. The Seller will execute and deliver the Transfer, and the Statement of Adjustments to the Purchaser’s Solicitor on their undertaking:
- (a) not to register the Transfer unless and until they hold in their trust account the balance of the Purchase Price pursuant to the Statement of Adjustment subject to the right of the purchaser to finance the purchase pursuant to paragraph 16;
 - (b) pay to the Seller’s solicitor the balance of the Purchase Price, as adjusted, on the Completion Date, upon lodging of the transfer and new mortgage documents and advance by the mortgagee of the mortgage proceeds, and after receipt of a satisfactory post registration search at the Land Titles Office indicating that in the normal course of Land Title Office routine, the title shall be issued in the name of the Purchaser subject to the Permitted Encumbrances and prior financial charges, and subject to the right to pay the funds to Seller’s solicitor on the undertaking to payout and discharge existing financial charges pursuant to paragraph 16;
 - (c) in the event the balance of the Purchase Price, subject to the adjustments provided for hereunder, is not made on the Completion Date to the Seller’s Solicitors, to:
 - (i) return the signed Transfer to Seller’s Solicitors in unregistered form, upon demand; or
 - (ii) if the Transfer has been submitted for registration to the Land Title Office, to apply to the Registrar of Land Title Office to have the Transfer withdrawn and to return the signed Transfer to the Seller’s Solicitors.

The Purchaser will pay all costs relating to the transfer of title to the Strata Lot, including Property Transfer Tax and applicable Goods and Services Tax. Upon submitting the Transfer for registration, the Purchaser consents to the Deposit being paid to the Seller and to be applied to the Purchase Price.

- 16. FINANCING AND CLEARING TITLE** – If the Purchaser is relying upon a new mortgage to finance the Purchase Price, the Purchaser may wait to pay the Purchase Price to the Seller on the Completion Date until after the transfer and new mortgage documents have been lodged for registration in the appropriate Land Title Office, but only if, before such lodging, the Purchaser has:
- (a) made available for tender to the Seller that portion of the Purchase Price, plus GST (if applicable), not secured by the new mortgage;
 - (b) fulfilled all the new mortgagee’s conditions for funding; and

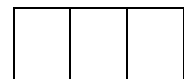

- (c) made available to the Seller a lawyer's undertaking to pay the Purchase Price, as adjusted, to the Seller, on the Completion Date, upon lodging of the transfer and new mortgage documents and advance by the mortgagee of the mortgage proceeds, and after receipt of a satisfactory post registration search at the Land Titles Office indicating that in the normal course of Land Title Office routine, the title shall be issued in the name of the Purchaser subject to the Permitted Encumbrances and prior financial charges.

If the Seller has existing financial charges to be cleared from title, the Seller, while still required to clear such charges, may wait to pay and discharge existing financial charges until immediately after receipt of the Purchase Price, plus GST (if applicable), but in this event, the Purchaser may pay the Purchase Price to the Seller's solicitor in trust on undertakings to:

- (a) pay to the charge holder the amount required by its written statement to payout and legally obligate the charge holder to discharge its security which is registered against the title to the Strata Lot on the trust condition that it will provide the Seller's solicitors with a registrable form of partial discharge of those charges within a reasonable period of time;
- (b) that upon receipt of the registrable partial discharges, file the same for registration in the Kamloops Land Title Office and provide the Purchaser's solicitors with registration particulars as soon as they are available.

The Purchaser acknowledges that the Seller's financing may remain as a charge against the common property of the Development, and as a charge in the Personal Property Registry until the Seller has completed the sale of the balance of the strata lots in the Development, whereupon the Seller covenants that such financing security will be discharged entirely. The Purchaser acknowledges that no undertaking shall be required from the solicitor for the Seller relating to the discharge of the Personal Property Registry charge.

- 17. REMEDIES OF THE SELLER** – If the Purchaser does not comply with the terms of this Agreement, the Seller may at its option, by notice in writing to the Purchaser, cancel this Agreement which shall then be of no further force and effect and the Deposit(s) shall be non-refundable and absolutely forfeited to the Seller on account of damages but without prejudice to any further right or remedies of the Seller.
- 18. NOTICE** – Any notices to be given under this Agreement, or notices of amendments to Disclosure Statements or consolidated Disclosure Statements shall be in writing addressed to the respective parties or their respective solicitors and sent by postage prepaid (air mail if to or from outside of Canada) or delivered by hand or transmitted by telecopy or e-mail to the addresses set out above, or such other address as any party may notify all other parties in accordance with this provision, and shall be deemed to have been received, if delivered, transmitted or e-mailed when delivered, transmitted or e-mailed and if mailed, on the fifth business day after such mailing. The Purchaser consents to receipt of notices as set out in this paragraph. The Purchaser must deliver written notice to the Seller, and/or the Seller's agent each time the Purchaser's email or postal address changes (an "Address Change Notice"). For the purposes of this Contract: (i) "Purchaser Email Address" means the email address for the Purchaser set out on page 1 of this Contract, as may be changed only by an Address Change Notice; (ii) "Purchaser Postal Address" means the postal address for the Purchaser set out on page 1 of this Contract, as may be changed only by an Address Change Notice;
- 19. GOVERNING LAW** – This Agreement shall be governed by the laws of the Province of British Columbia. The Seller and Purchaser agree to attorn to the jurisdiction of the British Columbia Courts which shall have the exclusive jurisdiction to determine any legal dispute arising out of this Agreement.
- 20. TIME OF THE ESSENCE** – Time shall be of the essence of this Agreement.

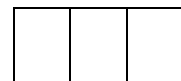

21. INTEREST IN LAND – Upon title to the Strata Lot being registered in the Land Title Office in the Purchaser’s name, the Purchaser shall become the absolute owner (fee simple) of the Strata Lot; however, until such time this Agreement of Purchase and Sale shall not create any interest in land and shall not be registered in the Land Title Office.

22. BINDING EFFECT – This Agreement shall be binding upon the Seller and the Purchaser and their respective heirs, executors, administrators, successors, and assigns.

23. ASSIGNMENT –

- (a) Without the Seller’s prior consent, any assignment of this Agreement is prohibited. Consent to an assignment may be unreasonably withheld by the Developer in the Developer’s sole discretion.
- (b) An assignment under the *Real Estate Development Marketing Act* is a transfer of some or all of the rights, obligations and benefits under a purchase agreement made in respect of a strata lot in a development property, whether the transfer is made by the purchaser under the purchase agreement to another person or is a subsequent transfer.
- (c) Each proposed party to an assignment agreement must provide the Seller with the information and records required under the *Real Estate Development Marketing Act*.
- (d) Before the Seller consents to the assignment of this Agreement, the Seller will be required to collect information and records under the *Real Estate Development Marketing Act* from each proposed party to an assignment agreement, including personal information respecting the following:
 - i. the party’s identity;
 - ii. the party’s contact and business information;
 - iii. the terms of the assignment agreement

Information and records collected by the Seller must be reported by the Seller to the administrator designated under the *Property Transfer Tax Act*. The information and records may only be used or disclosed for tax purposes and other purposes authorized by section 20.5 of the *Real Estate Development Marketing Act*, which includes disclosure to the Canada Revenue Agency.

- (e) If the Seller consents to an assignment of this Agreement, such consent will be conditional on the assignee(s) declaration of being exempt to the *Prohibition on the Purchase of Residential Property by Non-Canadians Act (Canada)* and the Purchaser and the assignee(s) entering into an assignment agreement and may, in the Seller’s sole discretion, be subject to an assignment fee in the amount equal to 2.5% of the Purchase Price, plus GST (the “Assignment Fee”), being paid to the Seller by the assignee(s) for the Strata Lot. The Purchaser shall be required to pay all of the Seller’s costs in connection with any assignment, including legal fees and disbursements in the amount of \$2,000 (the Administrative Fee”). In the instance that the assignee is the Purchaser’s spouse, sibling, parent, grandparent, child or grandchild, or a company solely controlled by the Purchaser then the Assignment Fee shall be waived, but an administration fee of \$750.00, plus GST will be required to be paid to the Seller. The Purchaser acknowledges that the Purchaser will at no time be entitled to advertise the Strata Lot for sale in any print or other media or use any of the Seller’s marketing material or images to advertise the offering of an assignment of this Agreement or the sale of the Strata Lot, prior to the Completion Date without written consent from the Seller. The Purchaser will not be released of its obligation to complete the purchase contemplated in this Agreement in the event of the assignee(s) default in their obligations under this Agreement, as assigned.

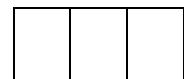

- 24. COST / GST** – The Purchaser will pay all taxes (including GST), costs, and expenses incurred in connection with the completion of the sale and purchase of the Strata Lot other than the costs of the Seller incurred in clearing title to the Strata Lot of financial encumbrances. If GST is not included in the Purchase Price, the Seller will remit the GST collected from the Purchaser to the Canada Revenue Agency and the Purchaser will be solely responsible to collect any applicable rebate of the GST.
- 25. MISCELLANEOUS** – This Agreement is the entire agreement between the parties and there are no other terms, conditions, representations, warranties or collateral agreements, express or implied, whether made by the Seller, any agent, employee, or representative of the Seller or any other person. All of the terms, conditions, representations, and warranties contained in this Agreement will survive closing and the transfer of the Strata Lot to the Purchaser. If the Purchaser is comprised of more than one person, the covenants and obligations of all parties comprising the Purchaser are joint and several.
- 26. PERSONAL INFORMATION** – The Purchaser and the Seller hereby consent to the collection, use and disclosure by the agents and salespersons described in any appendices or schedules hereto, the real estate boards of which those agents and salespersons are members and, if the Strata Lot is listed on a Multiple Listing Service, the real estate board that operates that Multiple Listing Service, of personal information about the Purchaser and the Seller: (a) for all purposes consistent with the transaction contemplated herein; (b) if the Strata Lot is listed on a Multiple Listing Service, for the purpose of the compilation, retention, and publication by the real estate board that operates the Multiple Listing Service and other real estate boards of any statistics including historical Multiple Listing Service of that real estate board and other real estate boards; (c) for enforcing codes of professional conduct and ethics for members of real estate boards; and (d) for the purposes (and to the recipients) described in the brochure published by the British Columbia Real Estate Association entitled Privacy Notice and Consent.

The Purchaser also consents to the collection, use, and disclosure of personal information contained in this Agreement, otherwise collected by or on behalf of the Seller for the purpose of assisting the Seller in securing financing for the Development and for additional purposes identified when or before personal information is collected.

- 27. COUNTERPARTS AND DELIVERY BY ELECTRONIC TRANSMISSION** – This Contract and any addendum hereto may be executed in any number of counterparts, each of which will be deemed to be an original and all of which, taken together, will be deemed to constitute one and the same instrument. Delivery of an executed copy of this Contract and any addendum hereto by any party by email in PDF format or by other means of electronic transmission (including, without limitation, through the use of software such as “DocuSign”, “Avesdo”, and other similar electronic execution software) will be as effective as personal delivery of an originally executed copy of this Contract by such party.
- 28. CURRENCY** – All payments contemplated herein will be in Canadian funds and all references herein to dollar amounts are references to dollars in the lawful currency of Canada unless otherwise specified. If any payments are made in a currency other than Canadian currency, the funds received will be converted to Canadian funds by the Seller’s Solicitors and the Purchaser will be credited with the Canadian funds actually received by the Seller’s Solicitors at the date of conversion, less any bank fees. The Seller will not be responsible for any delay in converting such payments, any fluctuations in exchange rates or bank fees or any charges in connection with any conversion or with any fees charged by any initiating, intermediate or receiving financial institutions in connection with any wire transfers.
- 29. CONTINUING MARKETING** – The Purchaser acknowledges that the Seller may retain strata lots in the Development for use as sales and administrative offices and/or display suites for marketing purposes or otherwise. The Purchaser agrees that, for so long as the Seller is the owner of any strata lots in the Development, the Seller and its marketing agents, and its and their affiliates, may carry out marketing, promotional and sales activities within the common property (including parking stalls and recreational facilities) of the Development or strata lots owned or leased by the Seller including, without limitation,

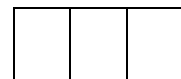

maintaining display suites, other display areas, parking areas and signage (including signage on the exterior of the Development) and permitting public access to same for the purpose of marketing any unsold strata lots. In addition, the Seller and its marketing agents and its and their affiliates may conduct tours of the Development from time to time with prospective purchasers and tenants of the Development or the Other Developments and hold events and other activities within the Development in connection with the marketing and sales activities.

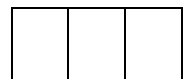

SCHEDULE "B"
STRATA LOT PLAN

--	--	--

SCHEDULE C
OPTIONS, FURNITURE, FIXTURES AND EQUIPMENT

--	--	--